

ABOUT US

IndoAsian, an Indian-origin brand **established in 1958**, has been a pioneer in electrical safety and innovation, trusted for delivering reliable, high quality solutions that empower homes, businesses, and communities.

With industry leading milestones such as introducing **6kA MCBs and RCCBs in India**, the brand has consistently set new standards in protection and performance. Its association with Group Legrand India further strengthened its innovation capabilities and expanded its reach, allowing IndoAsian to offer world class electrical and digital infrastructure.

Guided by the motto “**Enriching quality of life by ensuring safe, efficient and convenient use of electricity,**” the brand continues to uphold strong values, customer first innovation, and ethical, sustainable practices focused on **renewable energy and reducing environmental impact.**



CONTENT

| | |
|---|-------|
| Shynora WIRING ACCESSORIES | 04-17 |
| Glint [™] WIRING ACCESSORIES | 18-24 |
| ELVIRA WIRING ACCESSORIES | 25-31 |
| Doorsta DING DONG DOORBELL | 32-33 |
| PL9 PLUGS | 33 |
| Zosta [™] EXHAUST FANS | 34-35 |
| BULB HOLDER / CEILING ROSE | 36-37 |
| Caretron [™] MINIATURE CIRCUIT BREAKER (MCBS) | 38-42 |
| Caretron [™] ISOLATOR | 43 |
| Caretron [™] RESIDUAL CURRENT CIRCUIT BREAKER (RCCBS) | 44 |
| —optipro— MINIATURE CIRCUIT BREAKER (MCBS) | 45-46 |
| —optipro— ISOLATOR | 47 |
| AUTOMATIC CHANGEOVER WITH CURRENT LIMITER (ACCL) | 48 |
| Caretron [™] DISTRIBUTION BOARDS (DBS) | 49-53 |
| BUSBAR CHAMBER | 54-55 |
| TIME SWITCHES | 56 |
| —optium— MCCB - 1.0 (FIXED TM RANGE) | 57-61 |
| —optium— MCCB - 1.1 (FIXED TM RANGE) | 62 |
| —optium— MCCB - 2.0 (ADJUSTABLE TM RANGE) | 63-66 |
| —optium— MCCB ACCESSORIES | 67-70 |
| —optinova— SWITCH DISCONNECTOR / TSE (ON LOAD CHANGEOVER) | 71-74 |
| HRC FUSE LINKS & BASES | 75-76 |
| SWITCH DISCONNECTOR FUSES | 77-78 |
| Ambidex CHANGEOVER SWITCHES | 79-81 |

Add a touch of shine to your life



Shynora provides modular wiring device range blending elegant design with functionality for homes and commercial spaces.

Scan to know more about the product

Features

- Switches tested for up to 1 lakh on/off operations along with safety shuttered sockets
- Complete range of electronics, hospitality solutions and fast USB charging options (Type C 20W PD)
- High grade flame retardant polycarbonate material with laser etched markings
- Ranges tested for best-in-class quality with ISI, CRS & RoHS certification

Benefits

- Delivers long term value through high cycle durability testing
- Stylish design enhancing living spaces aesthetically
- Modular design offering flexibility & durability
- Assured quality with safety compliance and dependable performance



Shynora

Mechanisms White

Switches: • Polycarbonate Material • LED Based Indicator • Shrouded Terminal • ISI Marked



Switches 6A 230 V AC

HSN Code: 8536

| | | | Cat. Nos. | Description | Module | MRP ₹ / Unit | Pack |
|--|--------|--------------------------------------|-----------|-------------|----------|--------------|------|
|  810600  810604  810605 | 810600 | 6A 1 way Switch | 1 | 48 | 1/20/400 | | |
| | 810610 | 6A 2 way Switch | 1 | 100 | 1/20/200 | | |
| | 810602 | 6A 1 way Switch with Indicator | 1 | 102 | 1/20/200 | | |
| | 810604 | 6A 1 way Switch with "Light" Marking | 1 | 102 | 1/20/200 | | |
| | 810605 | 6A 1 way Switch with "Fan" Marking | 1 | 102 | 1/20/200 | | |



Switches 10A 230 V AC

HSN Code: 8536

| | | | Cat. Nos. | Description | Module | MRP ₹ / Unit | Pack |
|---|--------|---------------------------------|-----------|-------------|----------|--------------|------|
|  810673  810674  810675 | 810673 | 10A 1 way Switch | 1 | 54 | 1/20/200 | | |
| | 810674 | 10A 2 way Switch | 1 | 108 | 1/20/200 | | |
| | 810675 | 10A 1 way Switch with Indicator | 1 | 106 | 1/20/200 | | |



Switches 16A 230 V AC

HSN Code: 8536

| | | | Cat. Nos. | Description | Module | MRP ₹ / Unit | Pack |
|---|--------|---------------------------------|-----------|-------------|----------|--------------|------|
|  810601  810611 | 810601 | 16A 1 way Switch | 1 | 126 | 1/20/200 | | |
| | 810611 | 16A 2 way Switch | 1 | 172 | 1/10/100 | | |
| | 810603 | 16A 1 way Switch with Indicator | 1 | 154 | 1/20/200 | | |

Switches 20A 230V AC

HSN Code: 8536

| | | | Cat. Nos. | Description | Module | MRP ₹ / Unit | Pack |
|--|--------|---------------------------------|-----------|-------------|----------|--------------|------|
|  810606  810607  810612 | 810606 | 20A 1 way Switch | 1 | 170 | 1/20/200 | | |
| | 810607 | 20A 1 way Switch with Indicator | 1 | 196 | 1/20/200 | | |
| | 810609 | 20A SP 1 way Switch | 2 | 244 | 1/10/100 | | |
| | 810612 | 20A DP switch with Indicator | 2 | 220 | 1/10/100 | | |

Switches 25A 230 V AC

HSN Code: 8536

| | | | Cat. Nos. | Description | Module | MRP ₹ / Unit | Pack |
|--|--------|---------------------------------|-----------|-------------|----------|--------------|------|
|  810608 | 810608 | 25A 1 way Switch with Indicator | 1 | 230 | 1/20/200 | | |

Switches 32A 230 V AC

HSN Code: 8536

| | | | Cat. Nos. | Description | Module | MRP ₹ / Unit | Pack |
|--|--------|------------------------------|-----------|-------------|----------|--------------|------|
|  810613 | 810613 | 32A DP switch with indicator | 2 | 304 | 1/10/100 | | |

Shynora

Bell Push Button 6A 230 V AC

HSN Code: 8536



810615

810617

| Cat. Nos. | Description | Module | MRP ₹ / Unit | Pack |
|-----------|------------------------------------|--------|--------------|----------|
| 810615 | 6A Bell Push Switch | 1 | 108 | 1/20/200 |
| 810616 | 6A Bell Push Switch with Indicator | 1 | 112 | 1/20/200 |
| 810617 | 6A Bell Push Switch with Indicator | 2 | 174 | 1/10/100 |

Accessories for Switches

HSN Code: 8536



810650

| Cat. Nos. | Description | Module | MRP ₹ / Unit | Pack |
|-----------|--------------------------|--------|--------------|--------|
| 810650 | LED Indicator for switch | - | 44 | 1/5/25 |

Indian Standard Sockets 240 V AC

HSN Code: 8536

Sockets: • Child Safety Shutter • Shrouded Terminals • Smooth Plug Removal & Insertion



810620

810621

| Cat. Nos. | Description | Module | MRP ₹ / Unit | Pack |
|-----------|---|--------|--------------|----------|
| 810620 | 6A 3 pin Round Socket with shutter (ISI mark) | 2 | 132 | 1/20/200 |
| 810621 | 6A/16A 3 pin socket with shutter (ISI Mark) | 2 | 250 | 1/10/100 |

Dimmers and Fan Regulators • Laser Marking

HSN Code: 8538 & 8414



810641

810638

810639

| Cat. Nos. | Description | Module | MRP ₹ / Unit | Pack |
|-----------|--|--------|--------------|----------|
| 810641 | Light Dimmer - 400W | 1 | 482 | 1/10/100 |
| 810642 | Light Dimmer - 500W | 2 | 620 | 1/10/100 |
| 810638 | Fan 4 Step Regulator 100W (ISI mark) | 1 | 458 | 1/10/100 |
| 810639 | Fan Step Regulator 360 deg 100W (ISI mark) | 2 | 594 | 1/10/100 |
| 810640 | Fan 8 step Regulator 100W (ISI mark) | 2 | 696 | 1/10/100 |

Skirting Light

HSN Code: 9405



810649

| Cat. Nos. | Description | Module | MRP ₹ / Unit | Pack |
|-----------|----------------|--------|--------------|--------|
| 810649 | Skirting Light | 2 | 464 | 1/5/50 |

Indicator

HSN Code: 8536



810645

| Cat. Nos. | Description | Module | MRP ₹ / Unit | Pack |
|-----------|--------------------|--------|--------------|----------|
| 810645 | Flat Indicator Red | 1 | 140 | 1/20/200 |

Shynora

Bell Call Indicator

HSN Code: 8536

| | Cat. Nos. | Description | Module | MRP ₹ / Unit | Pack |
|---|-----------|---------------------|--------|--------------|----------|
|  810644 | 810644 | Bell Call Indicator | 1 | 794 | 1/20/100 |

Buzzer



HSN Code: 8536

| | Cat. Nos. | Description | Module | MRP ₹ / Unit | Pack |
|---|-----------|---------------|--------|--------------|----------|
|  810637 | 810637 | Buzzer - 230V | 1 | 338 | 1/20/100 |

Hospitality Function



Hotel Keycard Switch

HSN Code: 8538

| | Cat. Nos. | Description | Module | MRP ₹ / Unit | Pack |
|--|-----------|-----------------------------------|--------|--------------|----------|
|  | 810614 | 32A DP Keytag Switch (Mechanical) | 2 | 542 | 1/10 |
|  | 810678 | Keytag for (810614) | | 258 | 1/10/100 |
| | 810646 | Key Card SW 15A + KEY FOB | 2 | 2,790 | 1/10 |

Hotel "DND and MMR" Functions

HSN Code: 8538

| | Cat. Nos. | Description | Module | MRP ₹ / Unit | Pack |
|---|-----------|-------------------|--------|--------------|----------|
|  | 810647 | DND Internal Unit | 2 | 364 | 1/10/100 |
|  | 810648 | DND External Unit | 2 | 432 | 1/10/100 |

Shaver Socket

HSN Code: 8538

| | Cat. Nos. | Description | Module | MRP ₹ / Unit | Pack |
|---|-----------|---------------|--------|--------------|--------|
|  810666 | 810666 | Shaver Socket | 4 | 4918 | 1/5/20 |

Sockets and Connectors



TV Socket

HSN Code: 8536

| | Cat. Nos. | Description | Module | MRP ₹ / Unit | Pack |
|---|-----------|-------------|--------|--------------|----------|
|  810633 | 810633 | TV Socket | 1 | 126 | 1/20/200 |

Data & Voice

HSN Code: 8536

| | Cat. Nos. | Description | Module | MRP ₹ / Unit | Pack |
|---|-----------|---|--------|--------------|----------|
|  | 810631 | Telephone Socket - RJ11 with shutter | 1 | 124 | 1/20/200 |
|  | 810632 | Computer Socket - RJ45 Cat 6 with shutter | 1 | 706 | 1/20/200 |

Shynora

Sound (Electronic Bell)

HSN Code: 8536



810643

| Cat. Nos. | Description | Module | MRP ₹ / Unit | Pack |
|-----------|-----------------|--------|--------------|----------|
| 810643 | Electronic Bell | 2 | 376 | 1/10/100 |

Protectors and Accessories

Motor Starter

HSN Code: 8536



810664



810665

| Cat. Nos. | Description | Module | MRP ₹ / Unit | Pack |
|-----------|-------------------|--------|--------------|-------|
| 810664 | 16A MOTOR STARTER | 2 | 644 | 10/50 |
| 810665 | 25A MOTOR STARTER | 2 | 644 | 10/50 |

Modular MCB (IS : 608981:2002) • ISI Mark

HSN Code: 8536



810654



810655



810657



810660

| Cat. Nos. | Description | Module | MRP ₹ / Unit | Pack |
|-----------|-------------------------|--------|--------------|---------|
| 810654 | 6A MINI MCB SP C CURVE | 1 | 488 | 1/1/100 |
| 810655 | 10A MINI MCB SP C CURVE | 1 | 488 | 1/1/100 |
| 810656 | 16A MINI MCB SP C CURVE | 1 | 488 | 1/1/100 |
| 810657 | 20A MINI MCB SP C CURVE | 1 | 488 | 1/1/100 |
| 810658 | 25A MINI MCB SP C CURVE | 1 | 488 | 1/1/100 |
| 810659 | 32A MINI MCB SP C CURVE | 1 | 488 | 1/1/100 |
| 810660 | 16A MINI MCB DP C CURVE | 2 | 866 | 1/1/100 |
| 810661 | 20A MINI MCB DP C CURVE | 2 | 866 | 1/1/100 |
| 810662 | 25A MINI MCB DP C CURVE | 2 | 866 | 1/1/100 |
| 810663 | 32A MINI MCB DP C CURVE | 2 | 866 | 1/1/100 |

Power Unit

HSN Code: 8536



810625



810626

| Cat. Nos. | Description | Module | MRP ₹ / Unit | Pack |
|-----------|-----------------------------------|--------|--------------|------|
| 810625 | Power Unit Wth 20A MCB & 16A Plug | 3 | 1,162 | 1/10 |
| 810626 | Power Unit Wth 25A MCB & 16A Plug | 3 | 1,246 | 1/10 |

Effortless charging, simplified living



Scan to know more
about the product

Shynora USB Chargers deliver fast, safe charging with new Type C PD (20W) along with Type A+C options with CRS certified and RoHS compliant.

Features

- Type C PD 20W fast charging along with Type A+C(15W) charging option
- CRS certified with RoHS compliance
- Dual port option Type A+C(15W) and Type A+A(15W) USB charging option

Benefits



- Reduces cable clutter with versatile Type A/C/A+C port options
- Ensures fast charging to maintain continuous operation
- Matches Shynora aesthetics in white/cool grey mechanisms

Shynora

Electronic Function



USB Chargers (IS13252 (Part 1) / IEC 60950-1) • CRS Certified

HSN Code: 8536

| | | | Cat. Nos. | Description | Module | MRP ₹ / Unit | Pack |
|--|--------|---|-----------|-------------|----------|--------------|------|
|  810652  810651  810669 | 810652 | USB Charger 1500mA Type A | 1 | 1,084 | 1/10/100 | | |
| | 810651 | Double USB charger 3000mA Type A+A | 2 | 1,736 | 1/10/100 | | |
| | 810676 | USB Charger Type C 20W PD | 1 | 2,940 | 1/10/100 | | |
| | 810677 | USB Charger 3000mA, 15W Type A+C | 1 | 2,214 | 1/10/100 | | |
| | 810669 | Double USB Charger 3000mA, 15W Type A+C | 2 | 1,972 | 1/10/100 | | |

Accessories

HSN Code: 8538



| | | | Cat. Nos. | Description | Module | MRP ₹ / Unit | Pack |
|---|--------|----------------------|-----------|-------------|----------|--------------|------|
|  810667  810668 | 810667 | 1 Module Blank Plate | 1 | 32 | 1/40/400 | | |
| | 810668 | Cable Outlet | 1 | 100 | 1/20/100 | | |

Cool Grey Mechanisms

Switches: • Polycarbonate Material • LED Based Indicator • Shrouded Terminal • ISI Marked



Switches 6A 230 V AC

HSN Code: 8536

| | | | Cat. Nos. | Description | Module | MRP ₹ / Unit | Pack |
|--|--------|--------------------------------------|-----------|-------------|----------|--------------|------|
|  810700  810710  810704 | 810700 | 6A 1 way Switch | 1 | 56 | 1/20/400 | | |
| | 810710 | 6A 2 way Switch | 1 | 116 | 1/20/200 | | |
| | 810702 | 6A 1 way Switch with Indicator | 1 | 110 | 1/20/200 | | |
| | 810704 | 6A 1 way Switch with "Light" Marking | 1 | 122 | 1/20/200 | | |
| | 810705 | 6A 1 way Switch with "Fan" Marking | 1 | 122 | 1/20/200 | | |



Switches 16A 230 V AC

HSN Code: 8536

| | | | Cat. Nos. | Description | Module | MRP ₹ / Unit | Pack |
|---|--------|---------------------------------|-----------|-------------|----------|--------------|------|
|  810701  810703 | 810701 | 16A 1 way Switch | 1 | 154 | 1/20/200 | | |
| | 810711 | 16A 2 way Switch | 1 | 208 | 1/10/100 | | |
| | 810703 | 16A 1 way Switch with Indicator | 1 | 166 | 1/20/200 | | |

Switches 20A 230V AC

HSN Code: 8536

| | | | Cat. Nos. | Description | Module | MRP ₹ / Unit | Pack |
|--|--------|---------------------------------|-----------|-------------|----------|--------------|------|
|  810706  810707  810712 | 810706 | 20A 1 way Switch | 1 | 198 | 1/20/200 | | |
| | 810707 | 20A 1 way Switch with Indicator | 1 | 228 | 1/20/200 | | |
| | 810709 | 20A SP 1 way Switch | 2 | 280 | 1/10/100 | | |
| | 810712 | 20A DP switch with Indicator | 2 | 252 | 1/10/100 | | |

Shynora

Switches 25A 230 V AC

HSN Code: 8536

| | Cat. Nos. | Description | Module | MRP ₹ / Unit | Pack |
|---|-----------|---------------------------------|--------|--------------|----------|
|  810708 | 810708 | 25A 1 way Switch with Indicator | 1 | 250 | 1/20/200 |



Switches 32A 230 V AC

HSN Code: 8536

| | Cat. Nos. | Description | Module | MRP ₹ / Unit | Pack |
|---|-----------|------------------------------|--------|--------------|----------|
|  810713 | 810713 | 32A DP switch with indicator | 2 | 350 | 1/10/100 |

Bell Push Button 6A 230 V AC



HSN Code: 8536

| | Cat. Nos. | Description | Module | MRP ₹ / Unit | Pack |
|--|-----------|------------------------------------|--------|--------------|----------|
|  | 810715 | 6A Bell Push Switch | 1 | 126 | 1/20/200 |
|  | 810716 | 6A Bell Push Switch with Indicator | 1 | 138 | 1/20/200 |
| | 810717 | 6A Bell Push Switch with Indicator | 2 | 202 | 1/10/100 |

Indian Standard Sockets 240 V AC



HSN Code: 8536

Sockets: • Child Safety Shutter • Shrouded Terminals • Smooth Plug Removal & Insertion

| | Cat. Nos. | Description | Module | MRP ₹ / Unit | Pack |
|---|-----------|---|--------|--------------|----------|
|  810720 | 810720 | 6A 3 pin Round Socket with shutter (ISI mark) | 2 | 156 | 1/20/200 |
|  810721 | 810721 | 6A/16A 3 pin socket with shutter (ISI Mark) | 2 | 288 | 1/10/100 |

Dimmers & Fan Regulators • Laser Marking

HSN Code: 8538 & 8414

| | Cat. Nos. | Description | Module | MRP ₹ / Unit | Pack |
|---|-----------|--|--------|--------------|----------|
|  | 810741 | Light Dimmer - 400W | 1 | 552 | 1/10/100 |
|  | 810742 | Light Dimmer - 500W | 2 | 726 | 1/10/100 |
|  | 810738 | Fan Step Regulator 100W (ISI mark) | 1 | 528 | 1/10/100 |
| | 810739 | Fan Step Regulator 360 deg 100W (ISI mark) | 2 | 696 | 1/10/100 |
| | 810740 | Fan 8 step Regulator 100W (ISI mark) | 2 | 840 | 1/10/100 |

Skirting Light

HSN Code: 9405

| | Cat. Nos. | Description | Module | MRP ₹ / Unit | Pack |
|---|-----------|----------------|--------|--------------|--------|
|  810749 | 810749 | Skirting Light | 2 | 506 | 1/5/50 |

Shynora

Indicator

HSN Code: 8536



810745

| Cat. Nos. | Description | Module | MRP ₹ / Unit | Pack |
|-----------|--------------------|--------|--------------|----------|
| 810745 | Flat Indicator Red | 1 | 150 | 1/20/200 |

Buzzer

HSN Code: 8536



810737

| Cat. Nos. | Description | Module | MRP ₹ / Unit | Pack |
|-----------|---------------|--------|--------------|----------|
| 810737 | Buzzer - 230V | 1 | 390 | 1/20/100 |

Hospitality Function

Hotel Keycard Switch

HSN Code: 8538



810714



810746

| Cat. Nos. | Description | Module | MRP ₹ / Unit | Pack |
|-----------|-----------------------------------|--------|--------------|----------|
| 810714 | 32A DP Keytag Switch (Mechanical) | 2 | 624 | 1/10 |
| 810778 | Keytag for (810714) | | 298 | 1/10/100 |
| 810746 | Key Card SW 15A + KEY FOB | 2 | 3,568 | 1/10 |

Hotel "DND and MMR" Functions

HSN Code: 8538



810747



810748

| Cat. Nos. | Description | Module | MRP ₹ / Unit | Pack |
|-----------|-------------------|--------|--------------|----------|
| 810747 | DND Internal Unit | 2 | 448 | 1/10/100 |
| 810748 | DND External Unit | 2 | 508 | 1/10/100 |

Shaver Socket

HSN Code: 8538



810766

| Cat. Nos. | Description | Module | MRP ₹ / Unit | Pack |
|-----------|---------------|--------|--------------|--------|
| 810766 | Shaver Socket | 4 | 6,094 | 1/5/20 |

Sockets and Connectors

TV Socket

HSN Code: 8536



810733

| Cat. Nos. | Description | Module | MRP ₹ / Unit | Pack |
|-----------|-------------|--------|--------------|----------|
| 810733 | TV Socket | 1 | 146 | 1/20/200 |

Shynora

Data & Voice

HSN Code: 8536



810731

| Cat. Nos. | Description | Module | MRP ₹ / Unit | Pack |
|-----------|---|--------|--------------|----------|
| 810731 | Telephone Socket - RJ11 with shutter | 1 | 144 | 1/20/200 |
| 810732 | Computer Socket - RJ45 Cat 6 with shutter | 1 | 820 | 1/20/200 |

Protectors and Accessories

Motor Starter

HSN Code: 8536



810764



810765

| Cat. Nos. | Description | Module | MRP ₹ / Unit | Pack |
|-----------|-------------------|--------|--------------|-------|
| 810764 | 16A Motor Starter | 2 | 758 | 10/50 |
| 810765 | 25A Motor Starter | 2 | 758 | 10/50 |

Modular MCB (IS : 608981:2002) • ISI Mark

HSN Code: 8536



810754



810757



810758

| Cat. Nos. | Description | Module | MRP ₹ / Unit | Pack |
|-----------|-------------------------|--------|--------------|---------|
| 810754 | 6A Mini MCB SP C Curve | 1 | 564 | 1/1/100 |
| 810755 | 10A Mini MCB SP C Curve | 1 | 564 | 1/1/100 |
| 810756 | 16A Mini MCB SP C Curve | 1 | 564 | 1/1/100 |
| 810757 | 20A Mini MCB SP C Curve | 1 | 564 | 1/1/100 |
| 810758 | 25A Mini MCB SP C Curve | 1 | 564 | 1/1/100 |
| 810759 | 32A Mini MCB SP C Curve | 1 | 564 | 1/1/100 |

Power Unit

HSN Code: 8536



810725

| Cat. Nos. | Description | Module | MRP ₹ / Unit | Pack |
|-----------|------------------------------------|--------|--------------|------|
| 810725 | Power Unit with 20A MCB & 16A Plug | 3 | 1,354 | 1/10 |
| 810726 | Power Unit with 25A MCB & 16A Plug | 3 | 1,454 | 1/10 |

Electronic Function

USB Chargers (IS13252 (Part 1) / IEC 60950-1) • CRS Certified

HSN Code:8536



810752



810751



810769

| Cat. Nos. | Description | Module | MRP ₹ / Unit | Pack |
|-----------|---|--------|--------------|----------|
| 810752 | USB Charger 1500mA Type A | 1 | 1,354 | 1/10/100 |
| 810751 | Double USB charger 3000mA Type A+A | 2 | 2,004 | 1/10/100 |
| 810776 | USB Charger Type C 20W PD | 1 | 3,318 | 1/10/100 |
| 810777 | USB Charger 3000mA, 15W Type A+C | 1 | 2,398 | 1/10/100 |
| 810769 | Double USB Charger 3000mA, 15W Type A+C | 2 | 2,246 | 1/10/100 |

Shynora

Accessories

HSN Code: 8538

| Cat. Nos. | Description | Module | MRP ₹ / Unit | Pack |
|-----------|----------------------|--------|--------------|----------|
| 810767 | 1 Module Blank Plate | 1 | 38 | 1/40/400 |
| 810768 | Cable Outlet | 1 | 108 | 1/20/100 |



Shynora Plate Frame White

HSN Code: 8538

Plate & Frame • Strong Dimensional Stability

| Cat. Nos. | Description | Module | MRP ₹ / Unit | Pack |
|-----------|---------------------------------|--------|--------------|----------|
| 810800 | White Plate + Frame, 1 module | 1 | 102 | 1/10/100 |
| 810801 | White Plate + Frame, 2 module | 2 | 102 | 1/10/100 |
| 810802 | White Plate + Frame, 3 module | 3 | 152 | 1/10/100 |
| 810803 | White Plate + Frame, 4 module | 4 | 162 | 1/10/100 |
| 810804 | White Plate + Frame, 6 module | 6 | 224 | 1/10/100 |
| 810805 | White Plate + Frame, 8 module | 8 | 288 | 1/10/100 |
| 810806 | White Plate + Frame, 2X4 module | 8 | 288 | 1/5/25 |
| 810807 | White Plate + Frame, 9 module | 9 | 322 | 1/5/50 |
| 810808 | White Plate + Frame, 12 module | 12 | 380 | 1/5/25 |
| 810809 | White Plate + Frame, 16 module | 16 | 434 | 1/5/25 |
| 810810 | White Plate + Frame, 18 module | 18 | 508 | 1/5/25 |



810800



810801



810805



810810

Shynora Plate Frame Cool Grey

HSN Code: 8538

| Cat. Nos. | Description | Module | MRP ₹ / Unit | Pack |
|-----------|-------------------------------------|--------|--------------|----------|
| 810811 | Cool Grey Plate + Frame, 1 module | 1 | 126 | 1/10/100 |
| 810812 | Cool Grey Plate + Frame, 2 module | 2 | 126 | 1/10/100 |
| 810813 | Cool Grey Plate + Frame, 3 module | 3 | 184 | 1/10/100 |
| 810814 | Cool Grey Plate + Frame, 4 module | 4 | 198 | 1/10/100 |
| 810815 | Cool Grey Plate + Frame, 6 module | 6 | 278 | 1/10/100 |
| 810816 | Cool Grey Plate + Frame, 8 module | 8 | 320 | 1/10/100 |
| 810817 | Cool Grey Plate + Frame, 2X4 module | 8 | 320 | 1/5/25 |
| 810818 | Cool Grey Plate + Frame, 9 module | 9 | 394 | 1/5/50 |
| 810819 | Cool Grey Plate + Frame, 12 module | 12 | 462 | 1/5/25 |
| 810820 | Cool Grey Plate + Frame, 16 module | 16 | 520 | 1/5/25 |
| 810821 | Cool Grey Plate + Frame, 18 module | 18 | 626 | 1/5/25 |



810811



810812



810814



810816

Shynora Plate Frame Chrome

HSN Code: 8538

| Cat. Nos. | Description | Module | MRP ₹ / Unit | Pack |
|-----------|--------------------------------|--------|--------------|----------|
| 810833 | Chrome Plate + Frame, 1 module | 1 | 114 | 1/10/100 |
| 810834 | Chrome Plate + Frame, 2 module | 2 | 114 | 1/10/100 |



810833

Shynora

Shynora Plate Frame Chrome

HSN Code: 8538

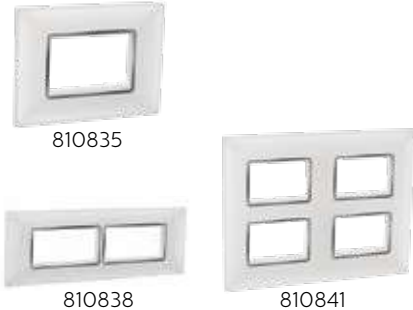
| | Cat. Nos. | Description | Module | MRP ₹ / Unit | Pack |
|---|-----------|----------------------------------|--------|--------------|----------|
|  | 810835 | Chrome Plate + Frame, 3 module | 3 | 160 | 1/10/100 |
| | 810836 | Chrome Plate + Frame, 4 module | 4 | 186 | 1/10/100 |
| | 810837 | Chrome Plate + Frame, 6 module | 6 | 260 | 1/10/100 |
| | 810838 | Chrome Plate + Frame, 8 module | 8 | 302 | 1/10/100 |
| | 810839 | Chrome Plate + Frame, 2X4 module | 8 | 302 | 1/5/25 |
| | 810840 | Chrome Plate + Frame, 9 module | 9 | 374 | 1/5/50 |
| | 810841 | Chrome Plate + Frame, 12 module | 12 | 428 | 1/5/25 |
| | 810842 | Chrome Plate + Frame, 16 module | 16 | 494 | 1/5/25 |
| | 810843 | Chrome Plate + Frame, 18 module | 18 | 590 | 1/5/25 |

Shynora Plate Frame Pink

HSN Code: 8538

| | Cat. Nos. | Description | Module | MRP ₹ / Unit | Pack |
|--|-------------------------------|--------------------------------|--------|--------------|----------|
|  | 810844 | Pink Plate + Frame, 1 module | 1 | 140 | 1/10/100 |
| | 810845 | Pink Plate + Frame, 2 module | 2 | 140 | 1/10/100 |
| | 810846 | Pink Plate + Frame, 3 module | 3 | 192 | 1/10/100 |
| | 810847 | Pink Plate + Frame, 4 module | 4 | 222 | 1/10/100 |
| | 810848 | Pink Plate + Frame, 6 module | 6 | 316 | 1/10/100 |
| | 810849 | Pink Plate + Frame, 8 module | 8 | 388 | 1/10/100 |
| | 810850 | Pink Plate + Frame, 2X4 module | 8 | 388 | 1/5/25 |
| | 810851 | Pink Plate + Frame, 9 module | 9 | 456 | 1/5/50 |
| | 810852 | Pink Plate + Frame, 12 module | 12 | 522 | 1/5/25 |
| | 810853 | Pink Plate + Frame, 16 module | 16 | 654 | 1/5/25 |
| 810854 | Pink Plate + Frame, 18 module | 18 | 712 | 1/5/25 | |

Shynora Plate Frame Milan Gold

HSN Code: 8538





| | Cat. Nos. | Description | Module | MRP ₹ / Unit | Pack |
|---|-------------------------------------|--------------------------------------|--------|--------------|----------|
|  | 810855 | Milan Gold Plate + Frame, 1 module | 1 | 140 | 1/10/100 |
| | 810856 | Milan Gold Plate + Frame, 2 module | 2 | 140 | 1/10/100 |
| | 810857 | Milan Gold Plate + Frame, 3 module | 3 | 192 | 1/10/100 |
| | 810858 | Milan Gold Plate + Frame, 4 module | 4 | 222 | 1/10/100 |
| | 810859 | Milan Gold Plate + Frame, 6 module | 6 | 316 | 1/10/100 |
| | 810860 | Milan Gold Plate + Frame, 8 module | 8 | 388 | 1/10/100 |
| | 810861 | Milan Gold Plate + Frame, 2X4 module | 8 | 388 | 1/5/25 |
| | 810862 | Milan Gold Plate + Frame, 9 module | 9 | 456 | 1/5/50 |
| | 810863 | Milan Gold Plate + Frame, 12 module | 12 | 522 | 1/5/25 |
| | 810864 | Milan Gold Plate + Frame, 16 module | 16 | 654 | 1/5/25 |
| 810865 | Milan Gold Plate + Frame, 18 module | 18 | 712 | 1/5/25 | |

Shynora



Metal Flush Boxes • Made of G.I. Sheet • Earth Terminal for Safety • Provision for Knockouts Available

• ISI Marked

HSN Code: 8538

| | Cat. Nos. | Description | Module | MRP ₹ / Unit | Pack |
|---|-----------|--|--------|--------------|------|
|  800172 | 800172 | Metal Flush Box, 1/2 Module | 1/2 | 78 | 40 |
|  800174 | 800173 | Metal Flush Box, 3 Module | 3 | 102 | 40 |
|  810867 | 800174 | Metal Flush Box, 4 Module | 4 | 120 | 40 |
|  800180 | 800176 | Metal Flush Box, 6 Module | 6 | 180 | 20 |
| | 800177 | Metal Flush Box, 8 Module (vertical) | 8 | 232 | 20 |
| | 800178 | Metal Flush Box, 8 Module (horizontal) | 8 | 232 | 20 |
| | 810867 | Metal Flush Box, 9 Module | 9 | 278 | 20 |
| | 800175 | Metal Flush Box, 12 Module | 12 | 304 | 10 |
| | 800179 | Metal Flush Box, 16 Module | 16 | 350 | 10 |
| | 800180 | Metal Flush Box, 18 Module | 18 | 382 | 10 |

Plastic Surface Boxes • Flame Retardant Material • Edge to Edge Fitting with Plate • ISI Marked HSN Code: 8538

| | Cat. Nos. | Description | Module | MRP ₹ / Unit | Pack |
|---|-----------|--|--------|--------------|------|
|  800182 | 800182 | Plastic Surface Box, 1/2 Module | 1/2 | 80 | 50 |
|  800184 | 800183 | Plastic Surface Box, 3 Module | 3 | 102 | 35 |
| | 800184 | Plastic Surface Box, 4 Module | 4 | 116 | 25 |
| | 800186 | Plastic Surface Box, 6 Module | 6 | 176 | 10 |
|  800187 | 800187 | Plastic Surface Box, 8 Module (vertical) | 8 | 240 | 15 |
|  800185 | 810866 | Plastic Surface Box, 8 Module (horizontal) | 8 | 252 | 10 |
| | 800185 | Plastic Surface Box, 12 Module | 12 | 302 | 10 |
| | 800189 | Plastic Surface Box, 16 Module | 16 | 352 | 10 |
| | 800190 | Metal Surface Box, 18 Module | 18 | 392 | 10 |

Dimensions

Cover Plates-Shynora

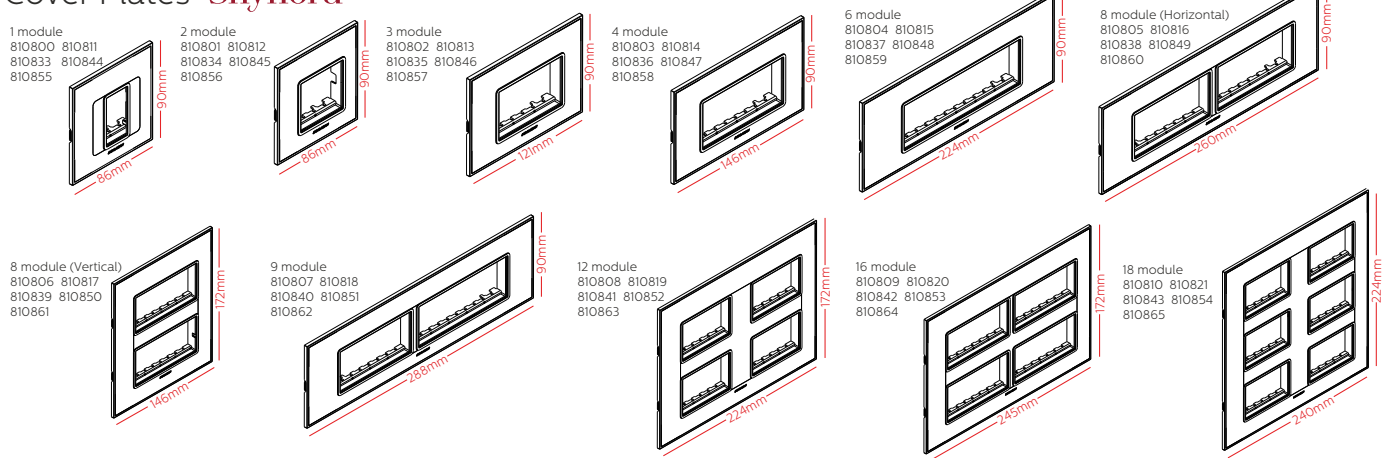

Flush Boxes-Metal

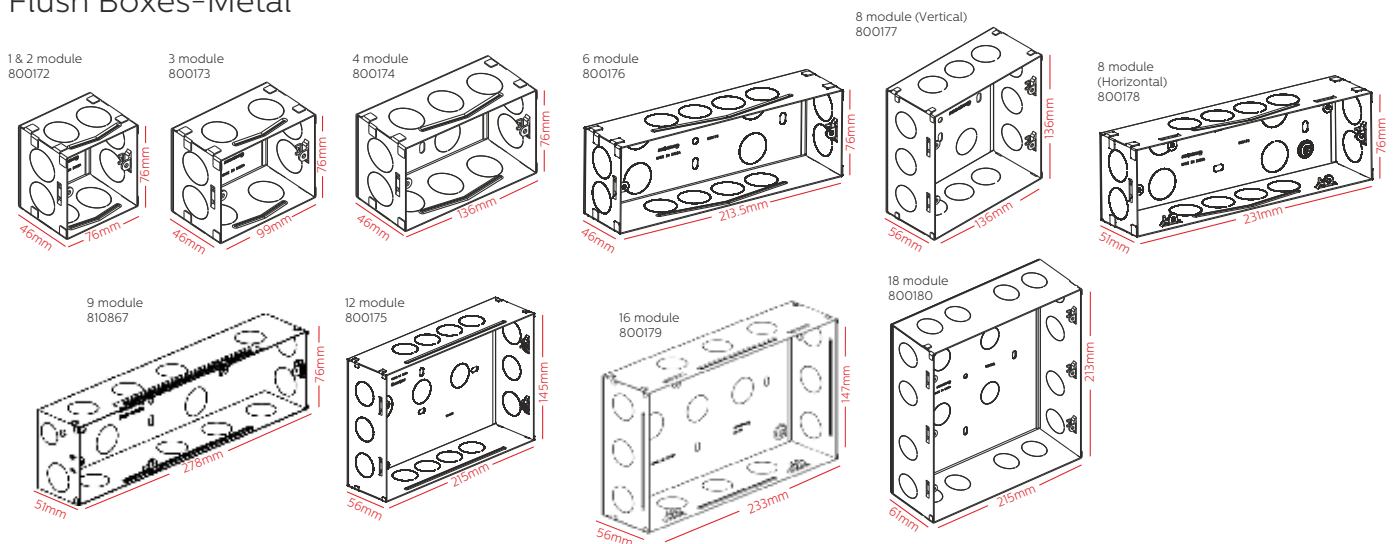

Surface Boxes-Plastic

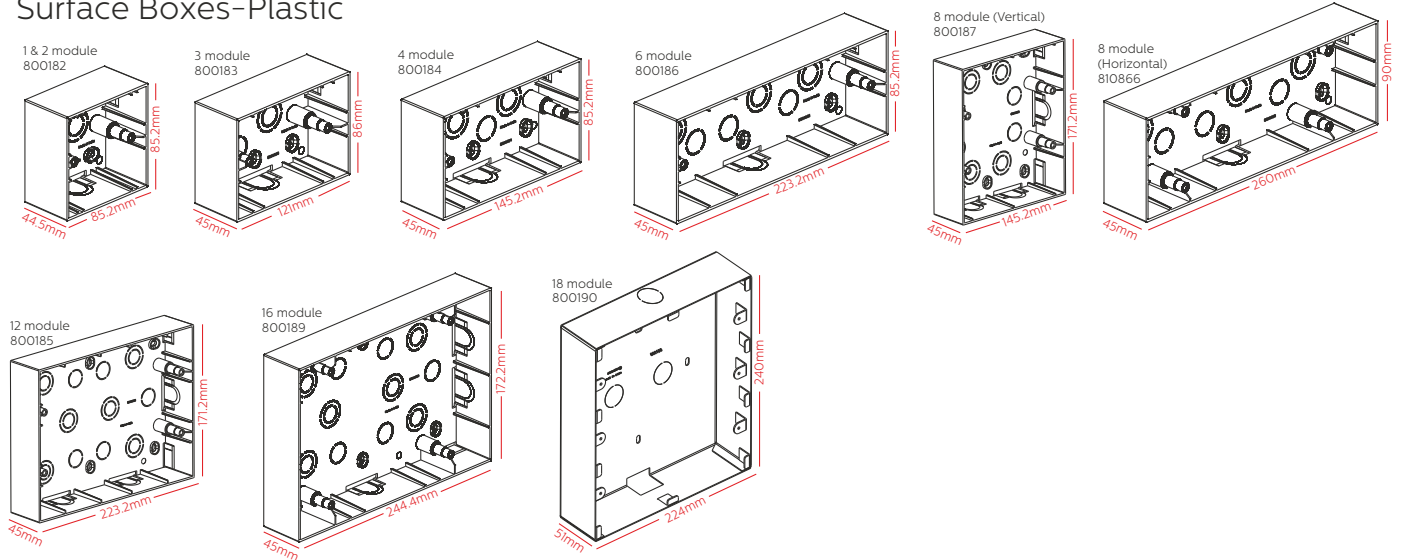

Elevate your space with refined elegance



Scan to know more about the product

Glint is a wiring device range designed to suit everyday interiors suitable for residential and commercial applications.

Features

- Switches tested for up to 1 lakh on/off operations along with safety shuttered sockets
- Modular design for quick assembly with heat resistant body for enhanced safety
- ISI and RoHS Certified

Benefits

- An economical modular system built for diverse applications
- Easy installation & low maintenance
- Ensures safe operation and long product life

Glint™

Mechanisms White

Switches: • Polycarbonate Material • LED Based Indicator • ISI Marked

Switches 6A 230 V AC

HSN Code: 8536

|  | | Cat. Nos. | Description | Module | MRP ₹ / Unit | Pack |
|---|--------|-----------|-----------------|--------|--------------|----------|
| 800000 | 800001 | 800000 | 6A 1 way Switch | 1 | 38 | 1/20/400 |
| | | 800001 | 6A 2 way Switch | 1 | 80 | 1/20/200 |

Switches 16A 230 V AC

HSN Code: 8536

|  | | | Cat. Nos. | Description | Module | MRP ₹ / Unit | Pack |
|---|--------|--------|-----------|---------------------------------|--------|--------------|----------|
| 800002 | 800003 | 800004 | 800002 | 16A 1 way Switch | 1 | 108 | 1/20/200 |
| | | | 800003 | 16A 2 way Switch | 1 | 138 | 1/10/100 |
| | | | 800004 | 16A 1 way Switch with indicator | 1 | 132 | 1/10/100 |

Switches 20A 230V AC

HSN Code: 8536

|  | | Cat. Nos. | Description | Module | MRP ₹ / Unit | Pack |
|---|--|-----------|------------------------------|--------|--------------|---------|
| 800005 | | 800005 | 20A DP Switch with indicator | 2 | 166 | 1/10/50 |

Switches 25A 230V AC

HSN Code: 8536

|  | | Cat. Nos. | Description | Module | MRP ₹ / Unit | Pack |
|---|--|-----------|---------------------------|--------|--------------|----------|
| 800089 | | 800089 | 25A Switch with Indicator | 1 | 142 | 1/10/100 |

Switches 32A 230 V AC

HSN Code: 8536

|  | | Cat. Nos. | Description | Module | MRP ₹ / Unit | Pack |
|---|--|-----------|------------------------------|--------|--------------|---------|
| 800006 | | 800006 | 32A DP Switch with indicator | 2 | 240 | 1/10/50 |

Bell Push Button 6A 230 V AC

HSN Code: 8536

|  | | Cat. Nos. | Description | Module | MRP ₹ / Unit | Pack |
|---|--------|-----------|-----------------------------|--------|--------------|----------|
| 800007 | 800008 | 800007 | 6A Bell Push with Indicator | 1 | 94 | 1/10/100 |
| | | 800008 | 6A Bell Push with Indicator | 2 | 140 | 1/10/100 |

Glint™

Mechanisms White

Sockets: • Child Safety Shutter • Smooth Plug Removal & Insertion

Indian Standard Sockets 240 V AC

HSN Code: 8536

| | Cat. Nos. | Description | Module | MRP ₹ / Unit | Pack |
|---|-----------|--|--------|--------------|----------|
|  800022 | 801800 | 6A 3 pin Round Socket with shutter (ISI mark) | 2 | 80 | 1/20/200 |
| | 800022 | 6A/16A 3 pin socket with shutter (ISI Mark) | 2 | 152 | 1/10/100 |

Dimmers and Fan Regulators •Laser Marking for Easy Identification

HSN Code: 8538 & 8414

| | Cat. Nos. | Description | Module | MRP ₹ / Unit | Pack |
|---|-----------|--|--------|--------------|----------|
|  800042 | 800042 | Light Dimmer -400W | 1 | 390 | 1/10/100 |
| | 800041 | Fan 4 Step Regulator -100W | 1 | 400 | 1/10/100 |
| | 800043 | Fan 4 Step Regulator -100W | 2 | 450 | 1/10/100 |
| | 800090 | Fan 5 Step Regulator -100W (ISI mark) | 2 | 398 | 1/10/100 |
| | 800091 | Fan 8 Step Regulator -100W (ISI mark) | 2 | 398 | 1/10/100 |
|  800043 | | | | | |

Skirting Light

HSN Code: 8536

| | Cat. Nos. | Description | Module | MRP ₹ / Unit | Pack |
|---|-----------|----------------|--------|--------------|--------|
|  800092 | 800092 | Skirting Light | 2 | 296 | 1/5/25 |

Indicator

HSN Code: 8536

| | Cat. Nos. | Description | Module | MRP ₹ / Unit | Pack |
|---|-----------|--------------------|--------|--------------|----------|
|  800033 | 800033 | Flat Indicator Red | 1 | 116 | 1/10/100 |

Buzzer

HSN Code: 8536

| | Cat. Nos. | Description | Module | MRP ₹ / Unit | Pack |
|---|-----------|---------------|--------|--------------|----------|
|  800040 | 800040 | Buzzer - 230V | 1 | 224 | 1/20/100 |

Hospitality Function

Hotel Keycard Switch

HSN Code: 8536

| | Cat. Nos. | Description | Module | MRP ₹ / Unit | Pack |
|---|-----------|-----------------------------------|--------|--------------|------|
|  800093 | 800093 | 32A DP Keytag Switch (Mechanical) | 2 | 392 | 1/10 |

Glint™

Hotel “DND and MMR” Functions

HSN Code: 8536

| Cat. Nos. | Description | Module | MRP ₹ / Unit | Pack |
|-----------|-------------------|--------|--------------|----------|
| 800094 | DND Internal Unit | 2 | 144 | 1/10/100 |
| 800095 | DND External Unit | 2 | 260 | 1/10/100 |



800094

Sockets and Connectors

TV Socket

HSN Code: 8536

| Cat. Nos. | Description | Module | MRP ₹ / Unit | Pack |
|-----------|-------------|--------|--------------|----------|
| 800032 | TV Socket | 1 | 80 | 1/20/100 |



800032

Data & Voice

HSN Code: 8536

| Cat. Nos. | Description | Module | MRP ₹ / Unit | Pack |
|-----------|-----------------------------|--------|--------------|----------|
| 800030 | Telephone Socket - RJ11 | 1 | 88 | 1/20/100 |
| 800031 | Computer Socket- RJ45 Cat 6 | 1 | 200 | 1/20/100 |



800030 800031

Protectors and Accessories

Modular MCB (IS : 608981:2002) • Laser Marking

HSN Code: 8536

| Cat. Nos. | Description | Module | MRP ₹ / Unit | Pack |
|-----------|-------------------------|--------|--------------|----------|
| 800097 | 6A MINI MCB SP C CURVE | 1 | 252 | 1/10/100 |
| 800098 | 10A MINI MCB SP C CURVE | 1 | 252 | 1/10/100 |
| 800010 | 16A MINI MCB SP C CURVE | 1 | 380 | 1/10/100 |
| 800011 | 20A MINI MCB SP C CURVE | 1 | 380 | 1/10/100 |
| 800012 | 25A MINI MCB SP C CURVE | 1 | 380 | 1/10/100 |
| 800013 | 32A MINI MCB SP C CURVE | 1 | 380 | 1/10/100 |



800097 800012

Motor Starter

HSN Code: 8536

| Cat. Nos. | Description | Module | MRP ₹ / Unit | Pack |
|-----------|-------------------|--------|--------------|---------|
| 800096 | 25A MOTOR STARTER | 2 | 414 | 1/10/50 |



800096

Electronic Function

USB Chargers (IS13252 (Part 1) / IEC 60950-1) • CRS Certified

HSN Code: 8536

| Cat. Nos. | Description | Module | MRP ₹ / Unit | Pack |
|-----------|---------------------------|--------|--------------|----------|
| 800044 | USB Charger 1500mA Type A | 1 | 942 | 1/10/100 |



800044

Glint™

Accessories • Spare Screw Caps

HSN Code: 8538

| Cat. Nos. | Description | Module | MRP ₹ / Unit | Pack |
|-----------|----------------------|--------|--------------|----------|
| 800051 | 1 Module Blank Plate | 1 | 28 | 1/20/200 |
| 800052 | 2 Module Blank Plate | 2 | 32 | 1/10/100 |
| 800059 | Screw Caps | 0 | 28 | 1/10/100 |

Plate & Frame: • Unique Design - Sleek & Curvy • Flame Retardant Material • Compatible with Standard Size of Metal Flush & Plastic Surface Boxes

Glint Single Plates White

HSN Code: 8538

| Cat. Nos. | Description | Module | MRP ₹ / Unit | Pack |
|-----------|-----------------------------|--------|--------------|----------|
| 800061 | 1 Module Plate | 1 | 62 | 1/10/100 |
| 800062 | 2 Module Plate | 2 | 62 | 1/10/100 |
| 800063 | 3 Module Plate | 3 | 88 | 1/10/100 |
| 800064 | 4 Module Plate | 4 | 104 | 1/10/100 |
| 800066 | 6 Module Plate | 6 | 130 | 1/5/50 |
| 800067 | 8 Module Plate (Vertical) | 8 | 182 | 1/5/25 |
| 800068 | 8 Module Plate (Horizontal) | 8 | 172 | 1/5/50 |
| 800065 | 12 Module Plate | 12 | 238 | 1/5/25 |
| 800069 | 16 Module Plate | 16 | 248 | 1/5/25 |
| 800070 | 18 Module Plate | 18 | 302 | 1/5/25 |

Glint Double Plates: • Aesthetic Design • Suitable for Metal Flush & Wooden Boxes • Comes with Regular & Self Tapping Screws

Plate & Frame

HSN Code: 8538

| Cat. Nos. | Description | Module | MRP ₹ / Unit | Pack |
|-----------|---------------------------------------|--------|--------------|----------|
| 800071 | White Plate + Frame, 1M | 1 | 92 | 1/10/100 |
| 800072 | White Plate + Frame, 2M | 2 | 92 | 1/10/100 |
| 800073 | White Plate + Frame, 3M | 3 | 118 | 1/10/100 |
| 800074 | White Plate + Frame, 4M | 4 | 150 | 1/10/100 |
| 800076 | White Plate + Frame, 6M | 6 | 188 | 1/10/50 |
| 800078 | White Plate + Frame, 8M (Vertical) | 8 | 268 | 1/5/25 |
| 800079 | White Plate + Frame, 8M (Horizontal) | 8 | 268 | 1/10/50 |
| 800080 | White Plate + Frame, 10M | 10 | 318 | 1/5/25 |
| 800082 | White Plate + Frame, 12M (Vertical) | 12 | 346 | 1/5/25 |
| 800084 | White Plate + Frame, 12M (Horizontal) | 12 | 346 | 1/5/25 |
| 800086 | White Plate + Frame, 16M | 16 | 392 | 1/5/25 |
| 800088 | White Plate + Frame, 18M | 18 | 426 | 1/5/25 |

Glint™

Metal Flush Boxes

HSN Code: 8538



800172



800174

| Cat. Nos. | Description | Module | MRP ₹ / Unit | Pack |
|-----------|--|--------|--------------|------|
| 800172 | Metal Flush Box, 1/2 Module | 1/2 | 78 | 40 |
| 800173 | Metal Flush Box, 3 Module | 3 | 102 | 40 |
| 800174 | Metal Flush Box, 4 Module | 4 | 120 | 40 |
| 800176 | Metal Flush Box, 6 Module | 6 | 180 | 20 |
| 800177 | Metal Flush Box, 8 Module (vertical) | 8 | 232 | 20 |
| 800178 | Metal Flush Box, 8 Module (horizontal) | 8 | 232 | 20 |
| 810867 | Metal Flush Box, 9 Module | 9 | 278 | 20 |
| 800175 | Metal Flush Box, 12 Module | 12 | 304 | 10 |
| 800179 | Metal Flush Box, 16 Module | 16 | 350 | 10 |
| 800180 | Metal Flush Box, 18 Module | 18 | 382 | 10 |

Plastic Surface Boxes

HSN Code: 8538



800182



800188

| Cat. Nos. | Description | Module | MRP ₹ / Unit | Pack |
|-----------|---|--------|--------------|------|
| 800182 | Plastic Surface Box, 1/2 Module | 1/2 | 80 | 50 |
| 800183 | Plastic Surface Box, 3 Module | 3 | 102 | 35 |
| 800184 | Plastic Surface Box, 4 Module | 4 | 116 | 25 |
| 800186 | Plastic Surface Box, 6 Module | 6 | 176 | 10 |
| 800187 | Plastic Surface Box, 8 Module (vertical) | 8 | 240 | 15 |
| 800188 | Plastic Surface Box 8 Module (horizontal) | 8 | 240 | 10 |
| 800185 | Plastic Surface Box, 12 Module | 12 | 302 | 10 |
| 800189 | Plastic Surface Box, 16 Module | 16 | 352 | 10 |
| 800190 | Metal Surface Box, 18 Module | 18 | 392 | 10 |

Dimensions

Cover Plates-Glint™

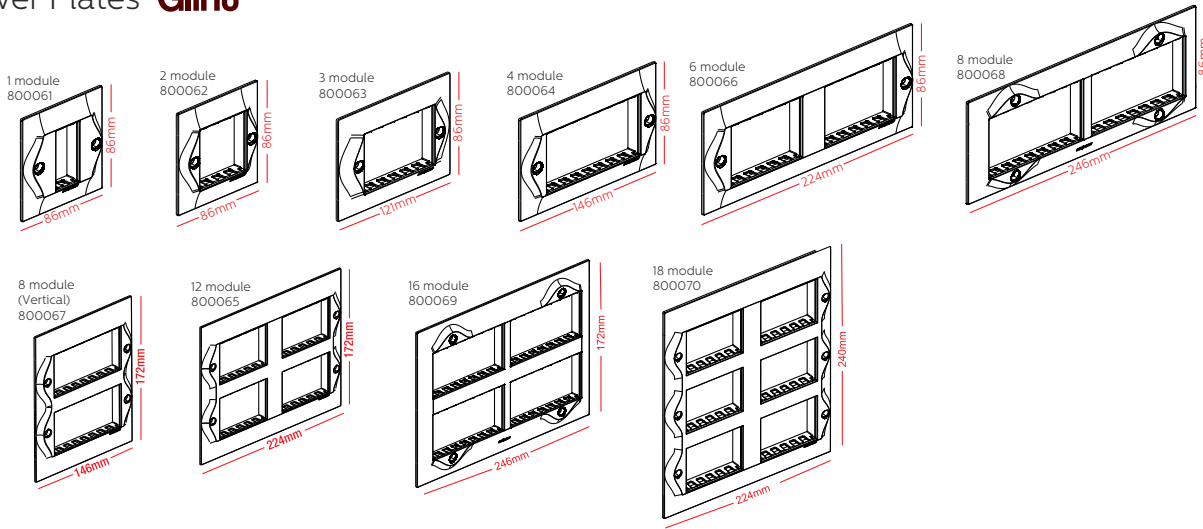

Flush Boxes-Metal

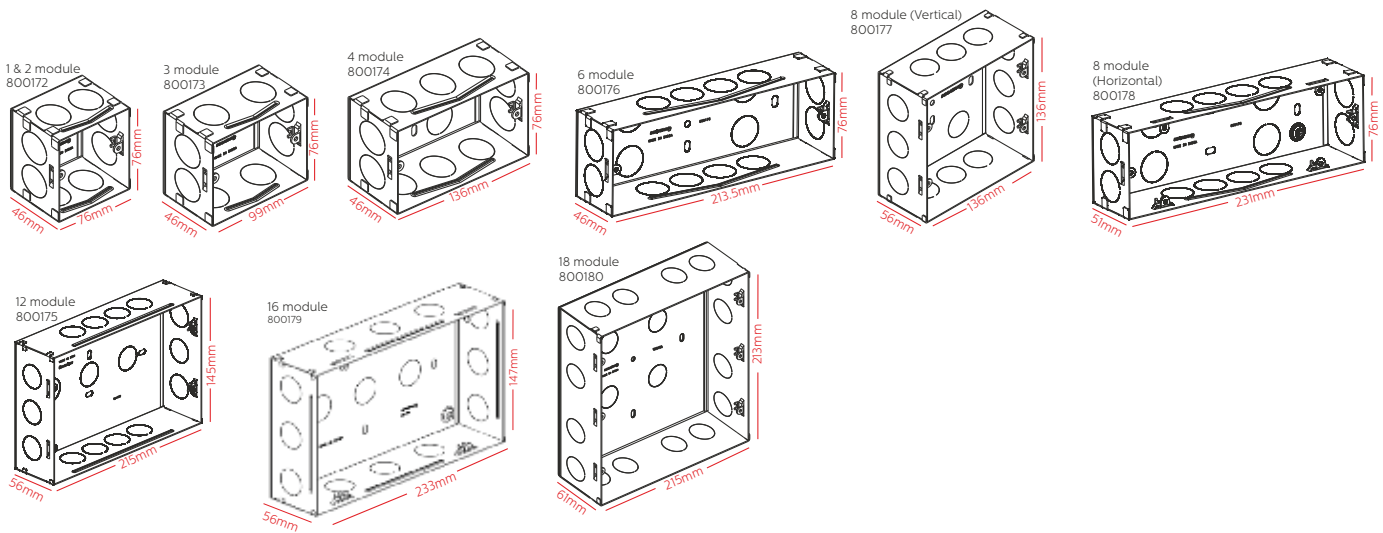

Surface Boxes-Plastic

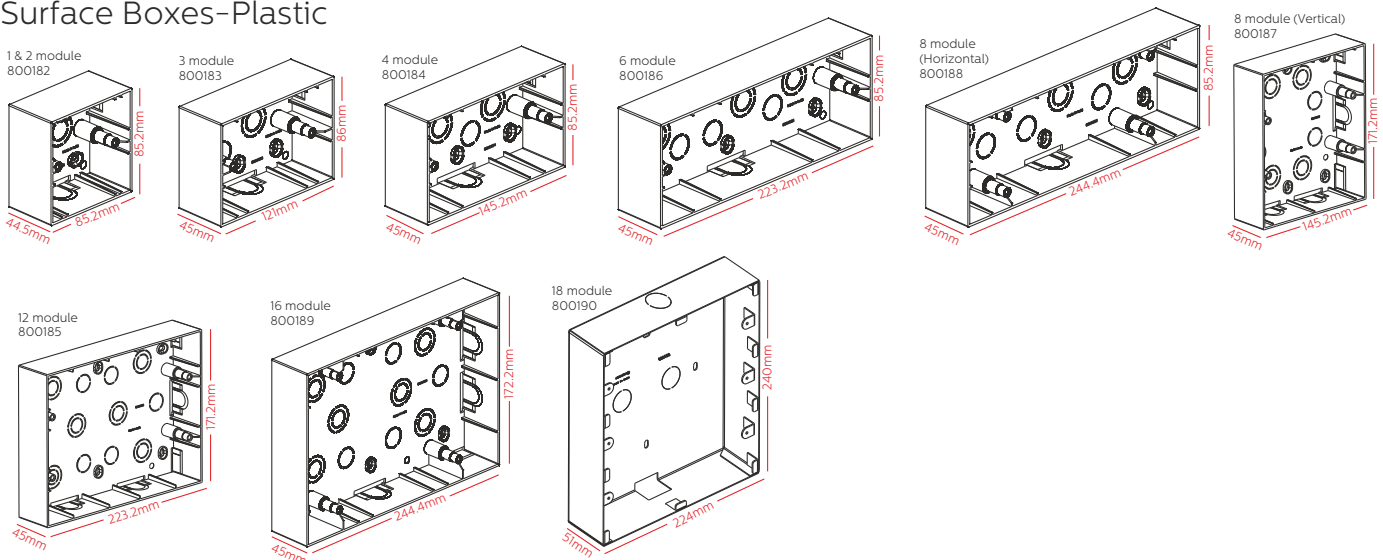

**We think better,
you live better**

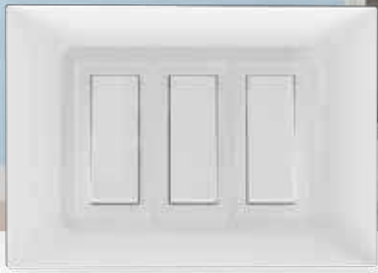

Scan to know more
about the product

Elvira is a modular range designed for modern residential and commercial spaces. It combines sleek design and durable performance, with ISI certified products.

Features

- Switches tested for up to 1 lakh on/off operations along with safety shuttered sockets
- Simple design enabling quick & easy installation
- Flame retardant plastic material used for end user safety
- ISI certified switches and sockets compliant with RoHS & BIS standards

Benefits

- Designed for long-term reliability with safety
- Balances modern aesthetics with safe operation
- Tested for electrical, mechanical, and thermal strength



ELVIRA

White Mechanisms

Switches: • Polycarbonate Material • LED Based Indicator • ISI Marked



Switches 6A 230 V AC

HSN Code: 8536

| | | Cat. Nos. | Description | Module | MRP ₹ / Unit | Pack |
|---|--|-----------|--------------------------------|--------|--------------|----------|
|  800100  800101 | | 800100 | 6A 1 way Switch | 1 | 42 | 1/20/400 |
| | | 800101 | 6A 2 way Switch | 1 | 98 | 1/20/100 |
| | | 800102 | 6A 1 way Switch with Indicator | 1 | 96 | 1/20/200 |



Switches 10A 230 V AC

HSN Code: 8536

| | | Cat. Nos. | Description | Module | MRP ₹ / Unit | Pack |
|---|--|-----------|---------------------------------|--------|--------------|----------|
|  800114  800115  800116 | | 800114 | 10A 1 way Switch | 1 | 46 | 1/20/400 |
| | | 800115 | 10A 2 way Switch | 1 | 102 | 1/20/100 |
| | | 800116 | 10A 1 way Switch with Indicator | 1 | 100 | 1/20/200 |

Switches 16A 230 V AC

HSN Code: 8536

| | | Cat. Nos. | Description | Module | MRP ₹ / Unit | Pack |
|---|--|-----------|---------------------------------|--------|--------------|----------|
|  800103  800104  800105 | | 800103 | 16A 1 way Switch | 1 | 124 | 1/20/200 |
| | | 800104 | 16A 2 way Switch | 1 | 168 | 1/10/100 |
| | | 800105 | 16A 1 way Switch with Indicator | 1 | 146 | 1/20/200 |

Switches 20A 230V AC

HSN Code: 8536

| | | Cat. Nos. | Description | Module | MRP ₹ / Unit | Pack |
|---|--|-----------|------------------------------|--------|--------------|---------|
|  800107 | | 800107 | 20A DP Switch with indicator | 2 | 214 | 1/10/50 |

Switches 25A 230 V AC

HSN Code: 8536

| | | Cat. Nos. | Description | Module | MRP ₹ / Unit | Pack |
|---|--|-----------|---------------------------------|--------|--------------|----------|
|  800106 | | 800106 | 25A 1 way Switch with Indicator | 1 | 222 | 1/10/100 |

Switches 32A 230 V AC

HSN Code: 8536

| | | Cat. Nos. | Description | Module | MRP ₹ / Unit | Pack |
|---|--|-----------|------------------------------|--------|--------------|---------|
|  800108 | | 800108 | 32A DP Switch with indicator | 2 | 296 | 1/10/50 |

ELVIRA

Bell Push Button 6A 230 V AC

HSN Code: 8536

| Cat. Nos. | Description | Module | MRP ₹ / Unit | Pack |
|-----------|-----------------------------|--------|--------------|----------|
| 800110 | 6A Bell Push with Indicator | 1 | 110 | 1/20/200 |
| 800111 | 6A Bell Push with Indicator | 2 | 172 | 1/10/100 |



Indian Standard Sockets 240 V AC:

HSN Code: 8536

Sockets • Child Safety Shutter • Smooth Plug Removal & Insertion

| Cat. Nos. | Description | Module | MRP ₹ / Unit | Pack |
|-----------|---|--------|--------------|----------|
| 802800 | 6A 3 pin Round Socket with Shutter (ISI Mark) | 2 | 104 | 1/20/200 |
| 800122 | 6A/16A 3 Pin Socket with Shutter (ISI Mark) | 2 | 206 | 1/10/50 |

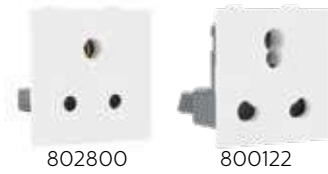

Dimmers and Fan Regulators: • Laser Marking for Easy Identification

HSN Code: 8538 & 8414

| Cat. Nos. | Description | Module | MRP ₹ / Unit | Pack |
|-----------|---------------------------------------|--------|--------------|----------|
| 800143 | Light Dimmer 400W | 1 | 466 | 1/10/100 |
| 800141 | Fan 4 Step Regulator 100W (ISI Mark) | 1 | 442 | 1/10/100 |
| 800142 | Fan 4 step Regulator 100W (ISI Mark) | 2 | 548 | 1/10/100 |
| 800139 | Fan 8 step Regulator 100W (ISI Mark) | 2 | 674 | 1/10/100 |



Skirting Light

HSN Code: 8536

| Cat. Nos. | Description | Module | MRP ₹ / Unit | Pack |
|-----------|----------------|--------|--------------|--------|
| 800155 | Skirting Light | 2 | 450 | 1/5/25 |



Indicator

HSN Code: 8536

| Cat. Nos. | Description | Module | MRP ₹ / Unit | Pack |
|-----------|--------------------|--------|--------------|----------|
| 800154 | Flat Indicator Red | 1 | 132 | 1/20/100 |



Buzzer

HSN Code: 8536

| Cat. Nos. | Description | Module | MRP ₹ / Unit | Pack |
|-----------|---------------|--------|--------------|----------|
| 800140 | Buzzer - 230V | 1 | 334 | 1/20/100 |



Bell Call Indicator

HSN Code: 8536

| Cat. Nos. | Description | Module | MRP ₹ / Unit | Pack |
|-----------|---------------------|--------|--------------|----------|
| 800144 | Bell Call Indicator | 1 | 712 | 1/20/100 |



ELVIRA

Sockets and Connectors



TV Socket

HSN Code: 8536

| | Cat. Nos. | Description | Module | MRP ₹ / Unit | Pack |
|---|-----------|-------------|--------|--------------|----------|
|  800132 | 800132 | TV Socket | 1 | 114 | 1/20/100 |

Data & Voice

HSN Code: 8536

| | Cat. Nos. | Description | Module | MRP ₹ / Unit | Pack |
|---|-----------|-----------------------------|--------|--------------|----------|
|  800130 | 800130 | Telephone Socket - RJ11 | 1 | 118 | 1/20/100 |
|  800131 | 800131 | Computer Socket- RJ45 Cat 6 | 1 | 292 | 1/20/100 |

Protectors and Accessories

Motor Starter



HSN Code: 8536

| | Cat. Nos. | Description | Module | MRP ₹ / Unit | Pack |
|--|-----------|-------------------|--------|--------------|---------|
|  800196 | 800196 | 25A Motor Starter | 2 | 544 | 1/10/50 |

MCB: (IS : 608981:2002) • Laser Marking

Modular MCB

HSN Code: 8536

| | Cat. Nos. | Description | Module | MRP ₹ / Unit | Pack |
|---|-----------|-------------------------|--------|--------------|----------|
|  800160 | 800160 | 16A MINI MCB SP C CURVE | 1 | 484 | 1/10/100 |
|  800156 | 800191 | 20A MINI MCB SP C CURVE | 1 | 484 | 1/10/100 |
| | 800156 | 25A MINI MCB SP C CURVE | 1 | 484 | 1/10/100 |
| | 800157 | 32A MINI MCB SP C CURVE | 1 | 484 | 1/10/100 |

Power Unit

HSN Code: 8536

| | Cat. Nos. | Description | Module | MRP ₹ / Unit | Pack |
|---|-----------|------------------------------------|--------|--------------|------|
|  800193 | 800193 | Power Unit with 20A MCB & 16A PLUG | 3 | 1,142 | 1/10 |
| | 800194 | Power Unit with 25A MCB & 16A PLUG | 3 | 1,226 | 1/10 |

Electronic Function (IS13252 (Part 1) / IEC 60950-1) • CRS Certified

USB Chargers

HSN Code: 8536

| | Cat. Nos. | Description | Module | MRP ₹ / Unit | Pack |
|---|-----------|---------------------------|--------|--------------|----------|
|  800145 | 800145 | USB charger 1500mA Type A | 1 | 1,066 | 1/10/100 |

ELVIRA

Hospitality Function

Hotel Keycard Switch

HSN Code: 8538

| | Cat. Nos. | Description | Module | MRP ₹ / Unit | Pack |
|---|-----------|---------------------|--------|--------------|--------|
|  800197 | 800197 | Key card Switch 15A | 2 | 2,722 | 1/1/10 |

Hotel "DND and MMR" Functions

HSN Code: 8538

| | Cat. Nos. | Description | Module | MRP ₹ / Unit | Pack |
|---|-----------|-------------------|--------|--------------|----------|
|  800192 | 800192 | DND INTERNAL UNIT | 2 | 234 | 1/10/100 |
| | 800195 | DND EXTERNAL UNIT | 2 | 278 | 1/10/100 |

Accessories

HSN Code: 8538







| | Cat. Nos. | Description | Module | MRP ₹ / Unit | Pack |
|--|-----------|----------------------|--------|--------------|----------|
|  800151 | 800151 | 1 Module Blank Plate | 1 | 30 | 1/20/200 |
|  800153 | 800152 | 2 Module Blank plate | 2 | 56 | 1/10/100 |
| | 800153 | Cable Outlet | 1 | 94 | 1/20/100 |

Plate & Frame: • Strong Dimensional Stability

Elvira Double Plates White



HSN Code: 8538

| | Cat. Nos. | Description | Module | MRP ₹ / Unit | Pack |
|---|-----------|--------------------------------------|--------|--------------|----------|
|  800161 | 800161 | White Plate + Frame, 1M | 1 | 98 | 1/10/100 |
| | 800162 | White Plate + Frame, 2M | 2 | 98 | 1/10/100 |
|  800163 | 800163 | White Plate + Frame, 3M | 3 | 136 | 1/10/100 |
| | 800164 | White Plate + Frame, 4M | 4 | 156 | 1/10/100 |
|  800166 | 800166 | White Plate + Frame, 6M | 6 | 202 | 1/10/100 |
| | 800167 | White Plate + Frame, 8M (Vertical) | 8 | 280 | 1/5/25 |
| | 800168 | White Plate + Frame, 8M (Horizontal) | 8 | 278 | 1/10/100 |
|  800170 | 800165 | White Plate + Frame, 12M | 12 | 374 | 1/5/25 |
| | 800169 | White Plate + Frame, 16M | 16 | 414 | 1/5/25 |
| | 800170 | White Plate + Frame, 18M | 18 | 500 | 1/5/25 |

ELVIRA



Metal Flush Boxes

HSN Code: 8538

| | | Cat. Nos. | Description | Module | MRP ₹ / Unit | Pack |
|---|---|-----------|--------------------------------------|--------|--------------|------|
|  |  | 800172 | Metal Flush Box, 1/2 Module | 1/2 | 78 | 40 |
| | | 800173 | Metal Flush Box, 3 Module | 3 | 102 | 40 |
| | | 800174 | Metal Flush Box, 4 Module | 4 | 120 | 40 |
| | | 800176 | Metal Flush Box, 6 Module | 6 | 180 | 20 |
| | | 800177 | Metal Flush Box, 8 Module (vertical) | 8 | 232 | 20 |
| | | 800178 | Metal Flush Box, 8 Module | 8 | 232 | 20 |
| | | 810867 | Metal Flush Box, 9 Module | 9 | 278 | 20 |
| | | 800175 | Metal Flush Box, 12 Module | 12 | 304 | 10 |
| | | 800179 | Metal Flush Box, 16 Module | 16 | 350 | 10 |
| | | 800180 | Metal Flush Box, 18 Module | 18 | 382 | 10 |

Plastic Surface Boxes

HSN Code: 8538

| | | Cat. Nos. | Description | Module | MRP ₹ / Unit | Pack |
|---|---|-----------|--|--------|--------------|------|
|  |  | 800182 | Plastic Surface Box, 1/2 Module | 1/2 | 80 | 50 |
| | | 800183 | Plastic Surface Box, 3 Module | 3 | 102 | 35 |
| | | 800184 | Plastic Surface Box, 4 Module | 4 | 116 | 25 |
| | | 800186 | Plastic Surface Box, 6 Module | 6 | 176 | 10 |
| | | 800187 | Plastic Surface Box, 8 Module (vertical) | 8 | 240 | 15 |
| | | 800188 | Plastic Surface Box 8 Module | 8 | 240 | 10 |
| | | 800185 | Plastic Surface Box, 12 Module | 12 | 302 | 10 |
| | | 800189 | Plastic Surface Box, 16 Module | 16 | 352 | 10 |
| | | 800190 | Metal Surface Box, 18 Module | 18 | 392 | 10 |

Dimensions

Cover Plates-**ELVIRA**

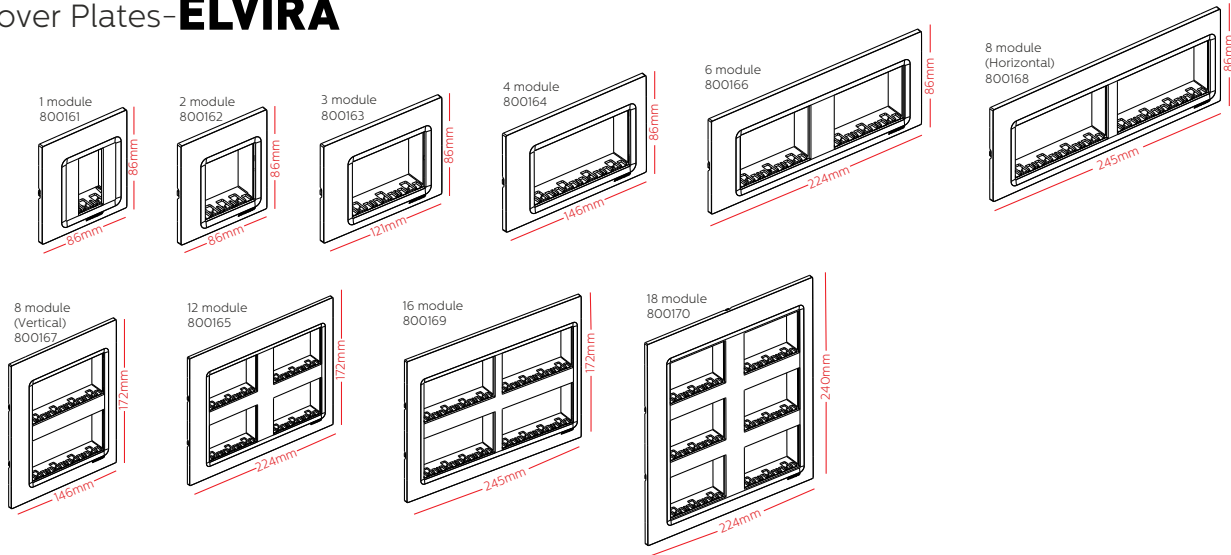

Flush Boxes-Metal

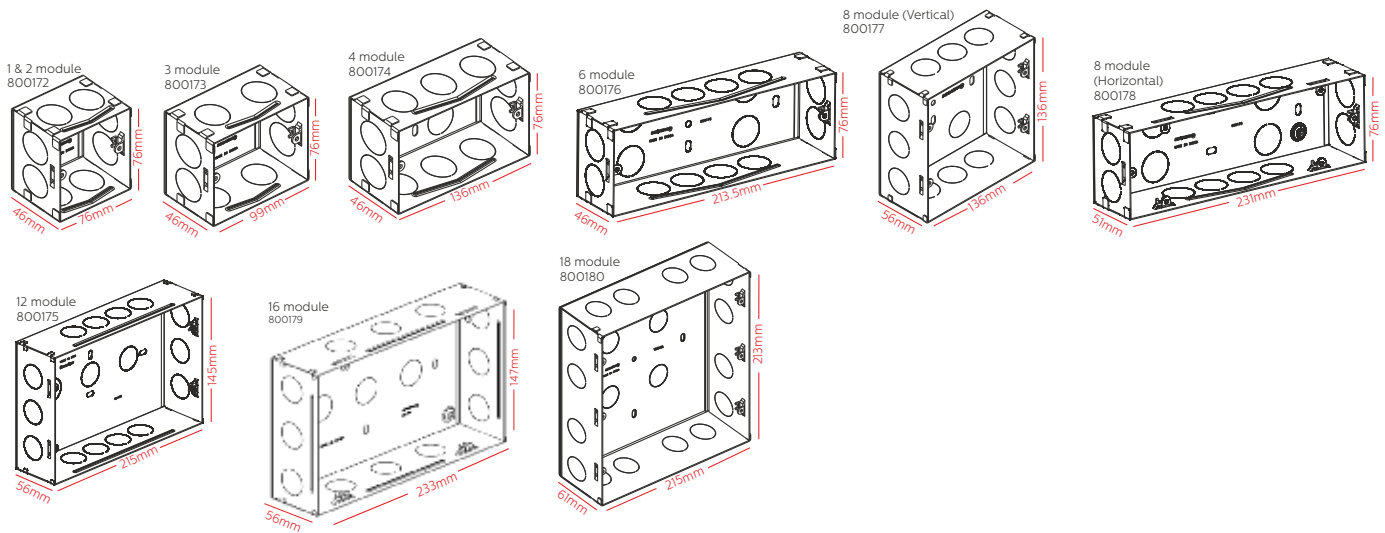

Surface Boxes-Plastic

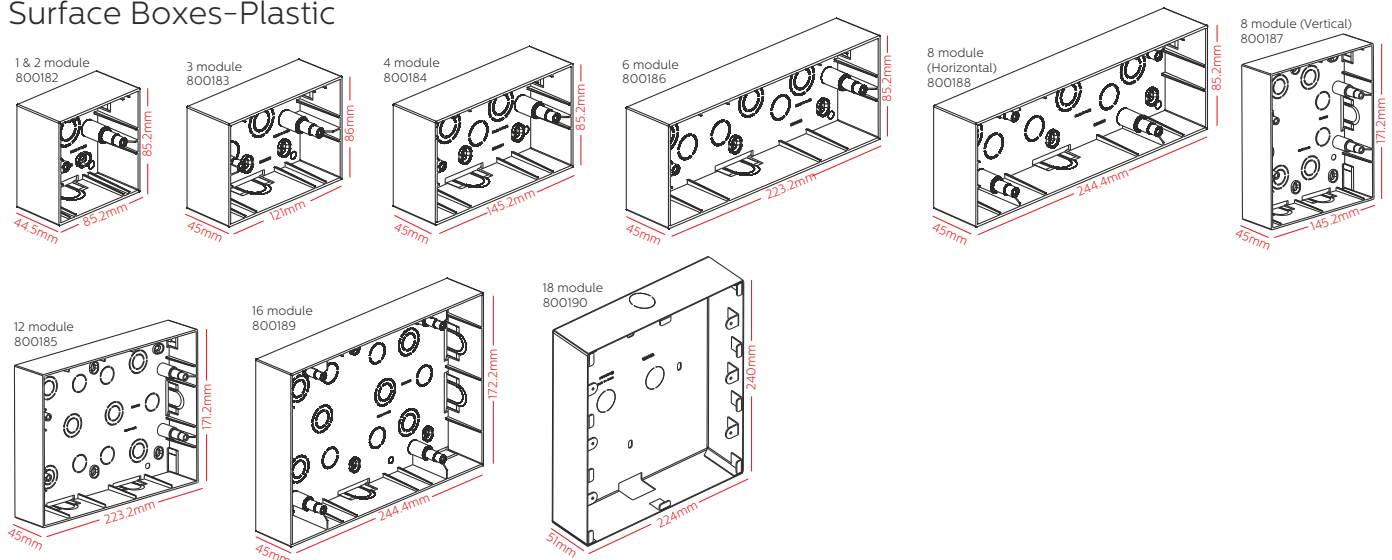

Where design meets safety



Scan to know more about the product

Doorsta doorbells are designed for clear sound. Built with high quality components, they provide dependable performance for residential and commercial spaces.

Features

- Made in India - BIS & RoHS compliant doorbell build for environmental safe usage
- Over current protection for consistent performance; works on 240 V AC
- Clear and audible chime for easy notification

Benefits

- Enhances safety for your home with stylish design
- Easy installation and operation
- Reliable performance for everyday use

Doorsta

Ding Dong Doorbell

• High Sound Output • BIS / RoHS Compliant • With Over Current Protection

HSN Code: 8536



698450 698451

| Cat. Nos. | Description | MRP ₹ / Unit | Pack |
|-----------|-----------------------------------|--------------|------|
| 698450 | Doorsta Ding Dong Doorbell (BIS) | 466 | 1/20 |
| 698451 | Doorsta Ding Dong Doorbell (BIS) | 492 | 1/20 |

3 Pin Plugs With Easy Grip

• White Matt Finish • ISI Marked

HSN Code: 8536



698470 698471

| Cat. Nos. | Description | MRP ₹ / Unit | Pack |
|-----------|---------------------------|--------------|--------|
| 698470 | 6A 3 Pin Plug (ISI mark) | 108 | 20/200 |
| 698471 | 16A 3 Pin Plug (ISI mark) | 162 | 10/100 |

A range to match your needs



Scan to know more
about the product

Zosta exhaust and axial fans are designed for efficient ventilation & quiet operation ensuring calm and comfortable environment.

Features

- Aerodynamic blade design for high air delivery and efficient airflow
- Powerful copper motor for better current carrying capacity and longer life
- RoHS compliant construction
- Silent operation

Benefits





- Improves air quality by quickly removing smoke, fumes and odours
- Long lasting durability with rust free plastic body
- Offers hassle free installation & maintenance

Zosta™

Exhaust Fan - White / Black

• Copper Motor • RoHS Compliant • Rust Free Body • Silent Operation

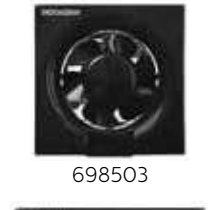

HSN Code: 8536

| | Cat. Nos. | Description | MRP ₹ / Unit | Pack |
|---|-----------|-------------------------|--------------|------|
|  698500 | 698500 | Exhaust Fan 150mm White | 2438 | 1/6 |
|  698501 | 698501 | Exhaust Fan 200mm White | 2732 | 1/6 |
|  698502 | 698502 | Exhaust Fan 250mm White | 3120 | 1/6 |
|  698503 | 698503 | Exhaust Fan 150mm Black | 2438 | 1/6 |
|  698504 | 698504 | Exhaust Fan 200mm Black | 2732 | 1/6 |
| 698505 | 698505 | Exhaust Fan 250mm Black | 3120 | 1/6 |

Axial Exhaust Fan - White

• Copper Motor • RoHS Compliant • Rust Free Body • Silent Operation

HSN Code: 8536

| | Cat. Nos. | Description | MRP ₹ / Unit | Pack |
|---|-----------|-------------------------------|--------------|------|
|  698506 | 698506 | Axial Exhaust Fan 100mm White | 1718 | 1/20 |
|  698507 | 698507 | Axial Exhaust Fan 150mm White | 1876 | 1/20 |

Bright ideas for
happy & safe living



Scan to know more
about the product

Bulb Holders are designed to provide a secure connection point for ceiling mounted lighting fixtures. Crafted from tough and lightweight material, it ensures durability while maintaining an attractive finish.

Features

- Long lasting polycarbonate plastic
- Ducts for heat dissipation
- Metal ring prevents deformation from overheating
- ISI certified bulb holders. All products are RoHS compliant

Benefits



- Ensures safe electrical connections for ceiling light fixtures
- Enhances aesthetics through glossy, dust resistant white finish
- Quick and easy installation

BULB HOLDER & CEILING ROSE

Fancy Batten Bulb Holder / Ceiling Rose

• Dynamic Design • Metal Ring Avoids Deformation

HSN Code: 8536

| | | | Cat. Nos. | Description | MRP ₹ / Unit | Pack |
|---|---|---|-----------|---|--------------|--------|
|  |  |  | 698473 | Fancy Batten Bulb Holder White (ISI mark) | 90 | 20/200 |
| 698473 | 698474 | 698475 | 698474 | Fancy Angle Bulb Holder White (ISI mark) | 90 | 20/200 |
| | | | 698475 | Fancy Ceiling Rose White | 58 | 20/200 |

Experience happiness through safe and secure products

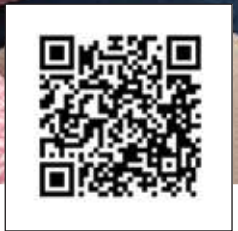

Scan to know more about the product

Caretron ensures complete safety for your home by protecting against electrical faults. Designed for modern homes, it delivers reliable and worry-free power every day.

Features

- ISI / CE certified as per IS/IEC 60898-1 standards
- Bi-connect terminals for cable / busbar connection with positive isolation
- 6kA breaking capacity with IP 20 degree of Protection

Benefits

- Enhances electrical safety by preventing damage from overloads and short circuits
- Ensures reliable electrical performance by disconnecting faulty circuits
- Hassle-free maintenance & long-term reliability

Caretron™

Caretron Miniature Circuit Breaker

- ISI / CE Marked as per IS/IEC 60898 -1 • Degree of Protection IP 20 • Bi-Connect Terminals • 25 sq. mm Terminals
- Breaking Capacity 6kA

B Curve Single Pole

HSN Code: 8536



810001

810002

| Rating (A) | Pack* | Item Number | MRP ₹ / Unit |
|------------|----------|-------------|--------------|
| 6 | 1/12/180 | 810000 | 246 |
| 10 | 1/12/180 | 810001 | 246 |
| 16 | 1/12/180 | 810002 | 246 |
| 20 | 1/12/180 | 810003 | 246 |
| 25 | 1/12/180 | 810004 | 246 |
| 32 | 1/12/180 | 810005 | 246 |
| 40 | 1/12/180 | 810006 | 560 |
| 50 | 1/12/180 | 810007 | 628 |
| 63 | 1/12/180 | 810008 | 628 |

B Curve Single Pole Neutral

HSN Code: 8536



810009

810010

| Rating (A) | Pack* | Item Number | MRP ₹ / Unit |
|------------|--------|-------------|--------------|
| 6 | 1/6/90 | 810009 | 829 |
| 10 | 1/6/90 | 810010 | 829 |
| 16 | 1/6/90 | 810011 | 829 |
| 20 | 1/6/90 | 810012 | 829 |
| 25 | 1/6/90 | 810013 | 829 |
| 32 | 1/6/90 | 810014 | 829 |
| 40 | 1/6/90 | 810015 | 1216 |
| 50 | 1/6/90 | 810016 | 1345 |
| 63 | 1/6/90 | 810017 | 1345 |

Caretron™

B Curve Double Pole

HSN Code: 8536



810018

810019

| Rating (A) | Pack* | Item Number | MRP ₹ / Unit |
|------------|--------|-------------|--------------|
| 6 | 1/6/90 | 810018 | 866 |
| 10 | 1/6/90 | 810019 | 866 |
| 16 | 1/6/90 | 810020 | 866 |
| 20 | 1/6/90 | 810021 | 866 |
| 25 | 1/6/90 | 810022 | 866 |
| 32 | 1/6/90 | 810023 | 866 |
| 40 | 1/6/90 | 810024 | 1278 |
| 50 | 1/6/90 | 810025 | 1429 |
| 63 | 1/6/90 | 810026 | 1429 |

C Curve Single Pole

HSN Code: 8536



810054

810055

| Rating (A) | Pack* | Item Number | MRP ₹ / Unit |
|------------|----------|-------------|--------------|
| 6 | 1/12/180 | 810054 | 248 |
| 10 | 1/12/180 | 810055 | 248 |
| 16 | 1/12/180 | 810056 | 248 |
| 20 | 1/12/180 | 810057 | 248 |
| 25 | 1/12/180 | 810058 | 248 |
| 32 | 1/12/180 | 810059 | 248 |
| 40 | 1/12/180 | 810060 | 574 |
| 50 | 1/12/180 | 810061 | 668 |
| 63 | 1/12/180 | 810062 | 668 |



Caretron™

Caretron Miniature Circuit Breaker

- ISI / CE Marked as per IS/IEC 60898 -1 • Degree of Protection IP 20 • Bi-Connect Terminals • 25 sq. mm Terminals
- Breaking Capacity 6kA

C Curve Single Pole Neutral

HSN Code: 8536



| | Rating (A) | Pack* | Item Number | MRP ₹ / Unit |
|--|------------|--------|-------------|--------------|
|  | 6 | 1/6/90 | 810063 | 916 |
|  | 10 | 1/6/90 | 810064 | 916 |
| | 16 | 1/6/90 | 810065 | 916 |
| | 20 | 1/6/90 | 810066 | 916 |
| | 25 | 1/6/90 | 810067 | 916 |
| | 32 | 1/6/90 | 810068 | 916 |
| | 40 | 1/6/90 | 810069 | 1289 |
| | 50 | 1/6/90 | 810070 | 1523 |
| | 63 | 1/6/90 | 810071 | 1523 |

810063

810064

C Curve Double Pole

HSN Code: 8536

| | Rating (A) | Pack* | Item Number | MRP ₹ / Unit |
|---|------------|--------|-------------|--------------|
|  | 6 | 1/6/90 | 810072 | 925 |
|  | 10 | 1/6/90 | 810073 | 925 |
| | 16 | 1/6/90 | 810074 | 925 |
| | 20 | 1/6/90 | 810075 | 925 |
| | 25 | 1/6/90 | 810076 | 925 |
| | 32 | 1/6/90 | 810077 | 925 |
| | 40 | 1/6/90 | 810078 | 1372 |
| | 50 | 1/6/90 | 810079 | 1549 |
| | 63 | 1/6/90 | 810080 | 1549 |

810072

810073

Caretron™

C Curve Three Pole

HSN Code: 8536



810081

| Rating (A) | Pack* | Item Number | MRP ₹ / Unit |
|------------|--------|-------------|--------------|
| 6 | 1/4/60 | 810081 | 1514 |
| 10 | 1/4/60 | 810082 | 1514 |
| 16 | 1/4/60 | 810083 | 1514 |
| 20 | 1/4/60 | 810084 | 1514 |
| 25 | 1/4/60 | 810085 | 1514 |
| 32 | 1/4/60 | 810086 | 1514 |
| 40 | 1/4/60 | 810087 | 2161 |
| 50 | 1/4/60 | 810088 | 2378 |
| 63 | 1/4/60 | 810089 | 2378 |

C Curve Three Pole Neutral

HSN Code: 8536



810090

| Rating (A) | Pack* | Item Number | MRP ₹ / Unit |
|------------|--------|-------------|--------------|
| 6 | 1/3/45 | 810090 | 1998 |
| 10 | 1/3/45 | 810091 | 1998 |
| 16 | 1/3/45 | 810092 | 1998 |
| 20 | 1/3/45 | 810093 | 1998 |
| 25 | 1/3/45 | 810094 | 1998 |
| 32 | 1/3/45 | 810095 | 1998 |
| 40 | 1/3/45 | 810096 | 2689 |
| 50 | 1/3/45 | 810097 | 2928 |
| 63 | 1/3/45 | 810098 | 2928 |

Caretron™

C Curve Four Pole

HSN Code: 8536



810099

| Rating (A) | Pack* | Item Number | MRP ₹ / Unit |
|------------|--------|-------------|--------------|
| 6 | 1/3/45 | 810099 | 2017 |
| 10 | 1/3/45 | 810100 | 2017 |
| 16 | 1/3/45 | 810101 | 2017 |
| 20 | 1/3/45 | 810102 | 2017 |
| 25 | 1/3/45 | 810103 | 2017 |
| 32 | 1/3/45 | 810104 | 2017 |
| 40 | 1/3/45 | 810105 | 2717 |
| 50 | 1/3/45 | 810106 | 2974 |
| 63 | 1/3/45 | 810107 | 2974 |

Isolator

- Conforms to IEC 60947-3 • Bi-Connect Terminals • Positive Isolation • Degree of Protection IP 20
- 25 sq. mm Terminals

Double Pole



810131

| Rating (A) | Pack* | Cat. Nos. | MRP ₹ / Unit |
|------------|--------|-----------|--------------|
| 40 | 1/6/90 | 810130 | 614 |
| 63 | 1/6/90 | 810131 | 758 |

Three Pole

HSN Code: 8536



810132

| Rating (A) | Pack* | Cat. Nos. | MRP ₹ / Unit |
|------------|--------|-----------|--------------|
| 40 | 1/4/60 | 810132 | 1102 |
| 63 | 1/4/60 | 810133 | 1236 |

*Subject to Change Based on Packaging Type

Four Pole

HSN Code: 8536



810134

| Rating (A) | Pack | Cat. Nos. | MRP ₹ / Unit |
|------------|--------|-----------|--------------|
| 40 | 1/3/45 | 810134 | 1364 |
| 63 | 1/3/45 | 810135 | 1429 |

Caretron™

Residual Current Circuit Breaker - RCCB

- ISI/CE marked as per IS/IEC12640 • Rated Conditional Short Circuit Current, ICC6kA • Degree of Protection IP 20
- Bi-Connect Terminals • 25 sq. mm Terminals

Double Pole

HSN Code: 8536

| | | Rating (A) | Sensitivity | Pack | Cat. Nos. | MRP ₹ / Unit |
|---|--------|------------|-------------|--------|-----------|--------------|
|  | 810150 | 25 | 30 mA | 1/6/90 | 810150 | 3255 |
| | 810153 | 25 | 100 mA | 1/6/90 | 810153 | 3401 |
| | | 25 | 300 mA | 1/6/90 | 810156 | 3401 |
| | | 40 | 30 mA | 1/6/90 | 810151 | 3606 |
| | | 40 | 100 mA | 1/6/90 | 810154 | 3663 |
| | | 40 | 300 mA | 1/6/90 | 810157 | 3663 |
| | | 63 | 30 mA | 1/6/90 | 810152 | 4594 |
| | | 63 | 100 mA | 1/6/90 | 810155 | 4644 |
| | | 63 | 300 mA | 1/6/90 | 810158 | 4644 |

Four Pole

HSN Code: 8536

| | | Rating (A) | Sensitivity | Pack | Cat. Nos. | MRP ₹ / Unit |
|---|--------|------------|-------------|--------|-----------|--------------|
|  | 810159 | 25 | 30 mA | 1/3/45 | 810159 | 4264 |
| | 810162 | 25 | 100 mA | 1/3/45 | 810162 | 4386 |
| | | 25 | 300 mA | 1/3/45 | 810165 | 4386 |
| | | 40 | 30 mA | 1/3/45 | 810160 | 4353 |
| | | 40 | 100 mA | 1/3/45 | 810163 | 4477 |
| | | 40 | 300 mA | 1/3/45 | 810166 | 4477 |
| | | 63 | 30 mA | 1/3/45 | 810161 | 4837 |
| | | 63 | 100 mA | 1/3/45 | 810164 | 4911 |
| | | 63 | 300 mA | 1/3/45 | 810167 | 4911 |

Engineered to perfection with a wide range and unmatched quality



Scan to know more about the product

Optipro MCBs are designed to provide protection for circuits in residential, commercial & industrial installations. These ranges safeguard electrical systems from overloads and short circuits.

Features

- Designed to perform in extreme conditions
- Visual status window (Red-ON/Green-OFF) for contact position
- Bi connect terminal with large terminal size

Benefits

- Protects against Overload and Short Circuit
- Simple clip-on mechanism that allows for quick and easy installation
- IP 20 degree protection ensures no live parts are exposed

—optipro™—

Miniature Circuit Breaker - MCB

- Conforms to IS/IEC 60898 • Short-Circuit Breaking Capacity 10kA • Line Load Reversibility • 35 sq. mm Terminals
- Biconnect Terminals • Frequency: 50 Hz • Clear Visual Indication of Contact Position

B Curve Single Pole

HSN Code: 8536



811010

811012

| Rating (A) | Pack | Cat. Nos. | MRP ₹ / Unit |
|------------|----------|-----------|--------------|
| 6 | 1/12/180 | 811008 | 317 |
| 10 | 1/12/180 | 811010 | 317 |
| 16 | 1/12/180 | 811012 | 317 |
| 20 | 1/12/180 | 811013 | 317 |
| 25 | 1/12/180 | 811014 | 317 |
| 32 | 1/12/180 | 811015 | 317 |
| 40 | 1/12/180 | 811016 | 736 |
| 50 | 1/12/180 | 811017 | 851 |
| 63 | 1/12/180 | 811018 | 851 |

B Curve Single Pole Neutral

HSN Code: 8536



811027

811033

| Rating (A) | Pack | Cat. Nos. | MRP ₹ / Unit |
|------------|--------|-----------|--------------|
| 6 | 1/6/90 | 811027 | 1082 |
| 10 | 1/6/90 | 811029 | 1082 |
| 16 | 1/6/90 | 811031 | 1082 |
| 20 | 1/6/90 | 811032 | 1082 |
| 25 | 1/6/90 | 811033 | 1082 |
| 32 | 1/6/90 | 811034 | 1082 |
| 40 | 1/6/90 | 811035 | 1528 |
| 50 | 1/6/90 | 811036 | 1733 |
| 63 | 1/6/90 | 811037 | 1733 |

—optipro™—

B Curve Double Pole

HSN Code: 8536



811046

811048

| Rating (A) | Pack | Cat. Nos. | MRP ₹ / Unit |
|------------|--------|-----------|--------------|
| 6 | 1/6/90 | 811046 | 1124 |
| 10 | 1/6/90 | 811048 | 1124 |
| 16 | 1/6/90 | 811050 | 1124 |
| 20 | 1/6/90 | 811051 | 1124 |
| 25 | 1/6/90 | 811052 | 1124 |
| 32 | 1/6/90 | 811053 | 1124 |
| 40 | 1/6/90 | 811054 | 1635 |
| 50 | 1/6/90 | 811055 | 1821 |
| 63 | 1/6/90 | 811056 | 1821 |

Optipro Isolator

- Conforms to IEC 60947-3 • CE Marked • Degree of Protection IP 20 • Large Terminal Size -35sqmm
- Biconnect Terminals

Double Pole

HSN Code: 8536



811552

| Rating (A) | Pack | Cat. Nos. | MRP ₹ / Unit |
|------------|--------|-----------|--------------|
| 80 | 1/6/90 | 811552 | 1139 |
| 100 | 1/6/90 | 811553 | 1139 |
| 125 | 1/6/90 | 811554 | 1228 |

Three Pole

HSN Code: 8536



811557

| Rating (A) | Pack | Cat. Nos. | MRP ₹ / Unit |
|------------|--------|-----------|--------------|
| 80 | 1/4/60 | 811557 | 1723 |
| 100 | 1/4/60 | 811558 | 1723 |
| 125 | 1/4/60 | 811559 | 1891 |

—optipro™—

Four Pole

HSN Code: 8536



811563

| Rating (A) | Pack | Cat. Nos. | MRP ₹ / Unit |
|------------|--------|-----------|--------------|
| 80 | 1/3/45 | 811562 | 2139 |
| 100 | 1/3/45 | 811563 | 2139 |
| 125 | 1/3/45 | 811564 | 2314 |

Automatic Changeover with Current Limiter

• As per IEC60947-6-1 • Intelligent Micro Controller Based Design • RoHS Compliant

HSN Code: 8536



810400



810401

| Rating (A) | Pack | Cat. Nos. | MRP ₹ / Unit |
|----------------------------|--------|-----------|--------------|
| SPN 30A Mains 1.5A DG ACCL | 1/3/45 | 810409 | 2608 |
| SPN 30A Mains 2.5A DG ACCL | 1/3/45 | 810410 | 2608 |
| SPN 30A Mains 3A DG ACCL | 1/3/45 | 810400 | 2608 |
| SPN 30A Mains 4A DG ACCL | 1/3/45 | 810401 | 2608 |
| SPN 30A Mains 5A DG ACCL | 1/3/45 | 810402 | 2608 |
| SPN 30A Mains 6A DG ACCL | 1/3/45 | 810403 | 2608 |
| SPN 30A Mains 9A DG ACCL | 1/3/45 | 810404 | 2608 |
| SPN 30A Mains 12A DG ACCL | 1/3/45 | 810405 | 2608 |
| SPN 30A Mains 15A DG ACCL | 1/3/45 | 810406 | 2608 |
| SPN 30A Mains 20A DG ACCL | 1/3/45 | 810407 | 2608 |
| SPN 30A Mains 30A DG ACCL | 1/3/45 | 810408 | 2608 |

Attractive design with minimal wall projection and matt finish



Scan to know more about the product

Caretron+ Distribution Boards are designed for superior safety, durability, and modern aesthetics. A perfect blend of performance and design for residential and commercial spaces.

Features

- Degree of Protection: IP 30 & IP 42
- Enhanced safety: Door earthing, Option for shrouding neutral links
- Wide range with SPN/TPN/VTPN/Phase Selector DBs
- Easy installation: insertion marks, key holes, ample wiring space

Benefits

- Fast, hassle-free installation and easy maintenance with ample space and clear circuit labels
- Enhances the visual appeal of interiors with a sleek and modern distribution board design
- Long service life with enhanced durability and corrosion resistance

Caretron™ +

CARETRON+ Distribution Boards

- Innovative Design with Minimal Wall Projection • Degree of Protection IP 30 and IP42 • Mechanical Impact Strength IK 08 • Suitable for Surface and Flush Mounting • Detachable Gland Plate • Box Insertion Marks
- Attractive White Shade (RAL 9010) Matt Finish • Circuit Identification Label

SPN Single Door

HSN Code: 8537



8105001

| No. of Way | Incomer + Outgoing | Pack | Cat. Nos. | MRP ₹ / Unit |
|------------|--------------------|------|-----------|--------------|
| 4 | 4 | 1/19 | 8105001 | 1099 |
| 6 | 6 | 1/18 | 8105011 | 1219 |
| 8 | 8 | 1/13 | 8105021 | 1366 |
| 12 | 12 | 1/11 | 8105031 | 1865 |
| 16 | 16 | 1/9 | 8105041 | 2295 |

SPN Double Door

HSN Code: 8537

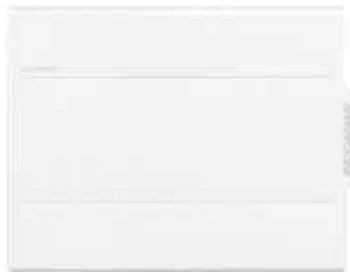

810505

| No. of Way | Incomer + Outgoing | Pack | Cat. Nos. | MRP ₹ / Unit |
|------------|--------------------|------|-----------|--------------|
| 4 | 4 | 1/14 | 810505 | 1925 |
| 6 | 6 | 1/12 | 810506 | 2116 |
| 8 | 8 | 1/10 | 810507 | 2347 |
| 12 | 12 | 1/9 | 810508 | 2831 |
| 16 | 16 | 1/7 | 810509 | 3483 |

Caretron™ +

TPN Single Door

HSN Code: 8537



8105121

| No. of Way | Incomer + Outgoing | Pack | Cat. Nos. | MRP ₹ / Unit |
|------------|--------------------|------|-----------|--------------|
| 4 | 4+12 | 1/8 | 8105101 | 3296 |
| 4 | 8+12 | 1/5 | 8105111 | 3732 |
| 6 | 4+18 | 1/5 | 8105121 | 3964 |
| 6 | 8+18 | 1/5 | 8105131 | 4538 |
| 8 | 8+24 | 1/4 | 8105141 | 5179 |
| 12 | 8+36 | 1/4 | 8105151 | 6978 |

TPN Double Door

HSN Code: 8537



810516

| No. of Way | Incomer + Outgoing | Pack | Cat. Nos. | MRP ₹ / Unit |
|------------|--------------------|------|-----------|--------------|
| 4 | 4+12 | 1/6 | 810516 | 4606 |
| 4 | 8+12 | 1/4 | 810517 | 4785 |
| 6 | 4+18 | 1/4 | 810518 | 5434 |
| 6 | 8+18 | 1/3 | 810519 | 5716 |
| 8 | 8+24 | 1/3 | 810520 | 6894 |
| 12 | 8+36 | 1/3 | 810521 | 8465 |

Caretron™ +

CARETRON+ Distribution Boards

• Innovative Design with Minimal Wall Projection • Degree of Protection IP 30 AND IP42 • Mechanical Impact Strength IK 08 • Suitable for Surface and Flush Mounting • Detachable Gland Plate • Attractive White Shade (RAL 9010) Matt Finish • Box Insertion Marks • Circuit Identification Label

VTPN MCB Incomer Double Door

HSN Code: 8537

810526

| No. of Way | Incomer + Outgoing | Pack | Cat. Nos. | MRP ₹ / Unit |
|------------|--------------------|------|-----------|--------------|
| 4 | 8+12 | 1 | 810526 | 11176 |
| 6 | 8+18 | 1 | 810527 | 13097 |
| 8 | 8+24 | 1 | 810528 | 14589 |
| 12 | 8+36 | 1 | 810529 | 19281 |

VTPN 125A MCCB I/C DD DB

HSN Code: 8537

810530

| No. of Way | Incomer + Outgoing | Pack | Cat. Nos. | MRP ₹ / Unit |
|------------|--------------------|------|-----------|--------------|
| 4 | Optium F1 + 12 | 1 | 810530 | 12917 |
| 6 | Optium F1 + 18 | 1 | 810531 | 14185 |
| 8 | Optium F1 + 24 | 1 | 810532 | 15447 |
| 12 | Optium F1 + 36 | 1 | 810533 | 19350 |

VTPN 250A MCCB I/C DD DB

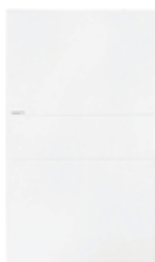
HSN Code: 8537

810534

| No. of Way | Incomer + Outgoing | Pack | Cat. Nos. | MRP ₹ / Unit |
|------------|--------------------|------|-----------|--------------|
| 4 | Optium F2 + 12 | 1 | 810534 | 16718 |
| 6 | Optium F2 + 18 | 1 | 810535 | 18364 |
| 8 | Optium F2 + 24 | 1 | 810536 | 19314 |
| 12 | Optium F2 + 36 | 1 | 810537 | 24195 |

Phase Selector 40A Double Door (Pre Fitted Selector Switches)

HSN Code: 8536

810546

| No. of Way | Incomer + Outgoing | Pack | Cat. Nos. | MRP ₹ / Unit |
|------------|--------------------|------|-----------|--------------|
| 4 | 8 + 12 | 1 | 810546 | 12594 |
| 6 | 8 + 18 | 1 | 810547 | 13790 |
| 8 | 8 + 24 | 1 | 810548 | 14463 |
| 12 | 8 + 36 | 1 | 810549 | 16538 |

Caretron™ +

Phase Selector 63A Double Door (Pre Fitted Selector Switches)

HSN Code: 8536



810550

| No. of Way | Incomer + Outgoing | Pack | Cat. Nos. | MRP ₹ / Unit |
|------------|--------------------|------|-----------|--------------|
| 4 | 8 + 12 | 1 | 810550 | 15114 |
| 6 | 8 + 18 | 1 | 810551 | 15830 |
| 8 | 8 + 24 | 1 | 810552 | 16536 |
| 12 | 8 + 36 | 1 | 810553 | 19324 |

Plug & Socket Box

HSN Code: 8536



8105561

| No. of Way | Incomer + Outgoing | Pack | Cat. Nos. | MRP ₹ / Unit |
|---|--------------------|------|-----------|--------------|
| 20A TP (compatible with 20A TP 'C' MCB) Metal Box | 3 | 1/8 | 8105561 | 2924 |
| 32A TP (compatible with 32A TP 'C' MCB) Metal Box | 3 | 1/8 | 8105571 | 4074 |
| 20A SP (supplied with 20A SP 'C' MCB) Metal Box | 1 | 1/24 | 8105581 | 1350 |
| 20A DP (supplied with 20A DP 'C' MCB) Metal Box | 2 | 1/24 | 8105591 | 1798 |

Metal Enclosure

HSN Code: 8537



8105601

| No. of Way | Incomer + Outgoing | Pack | Cat. Nos. | MRP ₹ / Unit |
|------------|--------------------|------|-----------|--------------|
| 1 | 1 | 1/50 | 8105601 | 531 |
| 2 | 2 | 1/36 | 8105611 | 531 |
| 3 | 3 | 1/36 | 8105621 | 620 |
| 4 | 4 | 1/32 | 8105631 | 620 |
| 6 | 6 | 1/24 | 8105641 | 741 |

Plastic Enclosure

HSN Code: 8536



810565

| No. of Way | Incomer + Outgoing | Pack | Cat. Nos. | MRP ₹ / Unit |
|------------|--------------------|--------|-----------|--------------|
| 1 & 2 | 1/2 | 1/5/45 | 810565 | 129 |
| 3 & 4 | 3/4 | 1/3/27 | 810566 | 204 |

Caretron™ +

Busbar Chamber

- Solution for Safe Power Distribution • Step Type Design • Available in Both SPN & TPN Configuration
- Also Available in IP54 Design

TPN BBC (CU-Busbar)

HSN Code: 8536



CPPI1015

| Item Description | Ingress Protection* | Cat. Nos. | MRP ₹ / Unit |
|--|---------------------|-----------|--------------|
| Spl. 32A TPN BBC (Cu) with 4 o/g ways | IP42 | CPPI1015 | 10130 |
| Spl. 63A TPN BBC (Cu) with 4 o/g ways | IP42 | CPPI1016 | 11290 |
| Spl. 100A TPN BBC (Cu) with 4 o/g ways | IP42 | CPPI1017 | 12510 |
| Spl. 200A TPN BBC (Cu) with 4 o/g ways | IP42 | CPPI1018 | 15480 |
| Spl. 250A TPN BBC (Cu) with 4 o/g ways | IP42 | CPPI1019 | 22030 |
| Spl. 320A TPN BBC (Cu) with 4 o/g ways | IP42 | CPPI1020 | 26760 |
| Spl. 400A TPN BBC (Cu) with 4 o/g ways | IP42 | CPPI1021 | 29740 |
| Spl. 630A TPN BBC (Cu) with 4 o/g ways | IP42 | CPPI1022 | 47570 |

Busbar Chamber

- Solution for Safe Power Distribution • Step Type Design
- Available in Both SPN & TPN Configuration • Also Available in IP54 Design

TPN-Type (Al.Busbar)

HSN Code: 8536



CPPI1023

| Item Description | Ingress Protection* | Cat. Nos. | MRP ₹ / Unit |
|---|---------------------|-----------|--------------|
| Spl. 32A TPN BBC (Al.) with 4 o/g ways | IP42 | CPPI1023 | 9520 |
| Spl. 63A TPN BBC (Al.) with 4 o/g ways | IP42 | CPPI1024 | 10130 |
| Spl. 100A TPN BBC (Al.) with 4 o/g ways | IP42 | CPPI1025 | 10680 |
| Spl. 200A TPN BBC (Al.) with 4 o/g ways | IP42 | CPPI1026 | 11290 |
| Spl. 250A TPN BBC (Al.) with 4 o/g ways | IP42 | CPPI1027 | 13650 |
| Spl. 320A TPN BBC (Al.) with 4 o/g ways | IP42 | CPPI1028 | 14870 |
| Spl. 400A TPN BBC (Al.) with 4 o/g ways | IP42 | CPPI1029 | 15480 |
| Spl. 630A TPN BBC (Al.) with 4 o/g ways | IP42 | CPPI1008 | 26600 |

Caretron™ +

MCCB Enclosure

• Solid Neutral Link for 3 Pole MCCBs

HSN Code: 8537



811985

| Description | Pack | Cat. Nos. | MRP ₹ / Unit |
|---|------|-----------|--------------|
| Optipro Enclosure for Frame-1 Optium 3 Pole MCCB | 1 | 811984 | 2335 |
| Optipro Enclosure for Frame-1 Optium 4 Pole MCCB | 1 | 811985 | 2335 |
| Optipro Enclosure for Frame-2 Optium 3 Pole MCCB | 1 | 811986 | 3517 |
| Optipro Enclosure for Frame-2 Optium 4 Pole MCCB | 1 | 811987 | 3517 |
| Optipro Enclosure for Frame-3 Optium 3 Pole MCCB | 1 | 811988 | 3517 |
| Optipro Enclosure for Frame-3 Optium 4 Pole MCCB | 1 | 811989 | 3517 |
| Optipro Enclosure for Frame-4 Optium 3 Pole MCCB | 1 | 811990 | 8753 |
| Optipro Enclosure for Frame-4 Optium 4 Pole MCCB | 1 | 811991 | 8753 |

Metal Clad Plug & Socket

AC Plug

HSN Code: 8536



811985

| Rating | Pack | Cat. Nos. | MRP ₹ / Unit |
|--------------------------|----------|-----------|--------------|
| 10A 2P+E, 230V AC | 1/10/100 | 810385 | 212 |
| 20A 2P+E, 230V AC | 1/10/100 | 810386 | 227 |
| 20A 3P+E, 230V / 415V AC | 1/10/100 | 810387 | 309 |
| 32A 3P+E, 230V / 415V AC | 1/10/100 | 810388 | 557 |

AC Socket

HSN Code: 8537



810389

| Rating | Pack | Cat Ref. | MRP ₹ / Unit |
|-----------------------------|----------|----------|--------------|
| 10A 2P+E, 230V AC | 1/10/100 | 810389 | 212 |
| 20A 2P+E, 230V AC | 1/10/100 | 810390 | 244 |
| 20A 3P+E, 230V / 415V AC | 1/10/100 | 810391 | 322 |
| 32A 3P+E, 230V / 415V AC | 1/10/100 | 810392 | 557 |

Caretron™ +

Time Switches

HSN Code: 9107



TA916422

| Model Name | Description | Cat Ref. | MRP ₹ / Unit |
|-------------------------------------|--|----------|--------------|
| 1mod DIN Daily | 1P Module, 24 hours program, Programmable every 15 min., backup of 100 hours, current capacity 16A, with 1 changeover (1 CO) | TA916422 | 5038 |
| 3mod DIN Daily | "3P Module, 24 hours program, Programmable every 15 min., backup of 100 hrs., current capacity 16A, with 1 changeover (1 CO)" | TA926453 | 5489 |
| "DIN Type Daily / Weekly with 1 CO" | "Programmable every 1 min., with backup of 6 years, 28 memory locations, current capacity 16A, weekly program, with 1 changeover (1 CO), Total 28 program" | TDA43110 | 6670 |

* For other models of Time Switches please contact nearest Branch Office.

Ensuring reliable performance at high ambient & humid environments



Scan to know more about the product

Optium MCCBs represent advanced MCCB technology, delivering intelligent protection, robust performance, and a wide range of options for complex electrical infrastructure, ensuring adaptability, safety, and durability.

Features

- Delivers breaking capacities ranging from 10kA – 50kA
- Wide range from 16A – 250A in compact frames and up to 1250A in larger frames
- Multiple series of ranges with fine-tunable protection settings

Benefits





- Offers reliable protection against overloads, short circuits, and ground faults across a wide performance range
- Flexibility in system design using adjustable settings and multiple frames
- Improved uptime and easier maintenance through long mechanical/electrical endurance

optium™
ALL THAT YOU NEED
MCCB

Optium 1.0 (Fixed TM MCCB Range)

• Ics =50% Icu as per IEC 60947-II • Suitable for Isolation Fixed Overload & Fixed Short Circuit Setting

HSN Code: 8536

| | Frame | Breaking Capacity | Rating | 3P | MRP ₹ / Unit | 4P | MRP ₹ / Unit |
|---|-------|-------------------|--------|--------|--------------|--------|--------------|
|  830701 | F1 | 10kA | 16 | 830701 | 3470 | 830710 | 4210 |
|  830702 | F1 | 10kA | 25 | 830702 | 3470 | 830711 | 4210 |
|  830703 | F1 | 10kA | 32 | 830703 | 3470 | 830712 | 4210 |
|  830704 | F1 | 10kA | 40 | 830704 | 3470 | 830713 | 4210 |
| | F1 | 10kA | 50 | 830705 | 3470 | 830714 | 4210 |
| | F1 | 10kA | 63 | 830706 | 3470 | 830715 | 4210 |
| | F1 | 10kA | 80 | 830707 | 3910 | 830716 | 5000 |
| | F1 | 10kA | 100 | 830708 | 3920 | 830717 | 5020 |
| | F1 | 10kA | 125 | 830709 | 5600 | 830718 | 7230 |

HSN Code: 8536

| | Frame | Breaking Capacity | Rating | 3P | MRP ₹ / Unit | 4P | MRP ₹ / Unit |
|---|-------|-------------------|--------|--------|--------------|--------|--------------|
|  830001 | F1 | 16kA | 16 | 830001 | 5770 | 830015 | 7050 |
|  830003 | F1 | 16kA | 25 | 830002 | 5770 | 830016 | 7050 |
|  830015 | F1 | 16kA | 32 | 830003 | 5770 | 830017 | 7050 |
|  830016 | F1 | 16kA | 40 | 830004 | 5770 | 830018 | 7050 |
| | F1 | 16kA | 50 | 830005 | 5770 | 830019 | 7050 |
| | F1 | 16kA | 63 | 830006 | 5770 | 830020 | 7050 |
| | F1 | 16kA | 80 | 830007 | 6060 | 830021 | 7800 |
| | F1 | 16kA | 100 | 830008 | 6060 | 830022 | 7800 |
| | F1 | 16kA | 125 | 830009 | 8390 | 830023 | 11030 |

optium™
ALL THAT YOU NEED
MCCB

Optium 1.0 (Fixed TM MCCB Range)

HSN Code: 8536



830031



830032



830034



830035

| Frame | Breaking Capacity | Rating | 3P | MRP ₹ / Unit | 4P | MRP ₹ / Unit |
|-------|-------------------|--------|--------|--------------|--------|--------------|
| F1 | 25kA | 16 | 830031 | 6950 | 830045 | 8300 |
| F1 | 25kA | 25 | 830032 | 6950 | 830046 | 8300 |
| F1 | 25kA | 32 | 830033 | 6950 | 830047 | 8300 |
| F1 | 25kA | 40 | 830034 | 6950 | 830048 | 8300 |
| F1 | 25kA | 50 | 830035 | 6950 | 830049 | 8300 |
| F1 | 25kA | 63 | 830036 | 6950 | 830050 | 8300 |
| F1 | 25kA | 80 | 830037 | 7150 | 830051 | 8710 |
| F1 | 25kA | 100 | 830038 | 7150 | 830052 | 8710 |
| F1 | 25kA | 125 | 830039 | 8610 | 830053 | 11460 |

Optium 1.0 (Fixed TM MCCB Range)

HSN Code: 8536



830061



830062



830063







830064

| Frame | Breaking Capacity | Rating | 3P | MRP ₹ / Unit | 4P | MRP ₹ / Unit |
|-------|-------------------|--------|--------|--------------|--------|--------------|
| F1 | 36kA | 16 | 830061 | 9190 | 830075 | 10510 |
| F1 | 36kA | 25 | 830062 | 9190 | 830076 | 10510 |
| F1 | 36kA | 32 | 830063 | 9190 | 830077 | 10510 |
| F1 | 36kA | 40 | 830064 | 9190 | 830078 | 10510 |
| F1 | 36kA | 50 | 830065 | 9190 | 830079 | 10510 |
| F1 | 36kA | 63 | 830066 | 9190 | 830080 | 10510 |
| F1 | 36kA | 80 | 830067 | 9330 | 830081 | 11080 |
| F1 | 36kA | 100 | 830068 | 9330 | 830082 | 11080 |
| F1 | 36kA | 125 | 830069 | 12860 | 830083 | 13370 |





optium™
ALL THAT YOU NEED
MCCB

Optium 1.0 (Fixed TM MCCB Range)

HSN Code: 8536

| | Frame | Breaking Capacity | Rating | 3P | MRP ₹ / Unit | 4P | MRP ₹ / Unit |
|--|-------|-------------------|--------|--------|--------------|--------|--------------|
|  830125 | F3 | 50kA | 16 | 830125 | 10630 | 830145 | 12930 |
|  830126 | F3 | 50kA | 25 | 830126 | 10630 | 830146 | 12930 |
| | F3 | 50kA | 32 | 830127 | 10630 | 830147 | 12930 |
| | F3 | 50kA | 40 | 830128 | 10630 | 830148 | 12930 |
| | F3 | 50kA | 50 | 830129 | 10630 | 830149 | 12930 |
|  830127 | F3 | 50kA | 63 | 830130 | 10630 | 830150 | 12930 |
|  830134 | F3 | 50kA | 80 | 830131 | 11170 | 830151 | 13320 |
| | F3 | 50kA | 100 | 830132 | 11170 | 830152 | 13320 |
| | F3 | 50kA | 125 | 830133 | 13030 | 830153 | 16520 |



HSN Code: 8536

| | Frame | Breaking Capacity | Rating | 3P | MRP ₹ / Unit | 4P | MRP ₹ / Unit |
|---|-------|-------------------|--------|--------|--------------|--------|--------------|
|  830090 | F2 | 16kA | 160 | 830090 | 8970 | 830095 | 13010 |
|  830091 | F2 | 16kA | 200 | 830091 | 11610 | 830096 | 15110 |
| | F2 | 16kA | 250 | 830092 | 12810 | 830097 | 15960 |
| | F2 | 25kA | 160 | 830100 | 10610 | 830105 | 13030 |
| | F2 | 25kA | 200 | 830101 | 14330 | 830106 | 17340 |
| | F2 | 25kA | 250 | 830102 | 18490 | 830107 | 21740 |
|  830092 | F2 | 36kA | 160 | 830110 | 13050 | 830115 | 16000 |
|  830100 | F2 | 36kA | 200 | 830111 | 16720 | 830116 | 21120 |
| | F2 | 36kA | 250 | 830112 | 21820 | 830117 | 28700 |

optium™
ALL THAT YOU NEED
MCCB

Optium 1.0 (Fixed TM MCCB Range)



HSN Code: 8536

| | | Frame | Breaking Capacity | Rating | 3P | MRP ₹ / Unit | 4P | MRP ₹ / Unit |
|---|---|-------|-------------------|--------|--------|--------------|--------|--------------|
|  |  | F3 | 50kA | 160 | 830134 | 14580 | 830154 | 20020 |
| | | F3 | 50kA | 200 | 830135 | 17550 | 830155 | 24630 |
| | | F3 | 50kA | 250 | 830136 | 22560 | 830156 | 29980 |

830134

830135

HSN Code: 8536



| | | Frame | Breaking Capacity | Rating | 3P | MRP ₹ / Unit | 4P | MRP ₹ / Unit |
|--|--|-------|-------------------|--------|--------|--------------|--------|--------------|
|  |  | F4 | 36kA | 315 | 830165 | 29470 | 830175 | 33620 |
| | | F4 | 36kA | 400 | 830166 | 31140 | 830176 | 35520 |
| | | F4 | 36kA | 500 | 830167 | 34850 | 830177 | 40330 |
| | | F4 | 36kA | 630 | 830168 | 36940 | 830178 | 42440 |

830165

830166

Optium 1.0 (Fixed TM MCCB Range)

HSN Code: 8536

| | | Frame | Breaking Capacity | Rating | 3P | MRP ₹ / Unit | 4P | MRP ₹ / Unit |
|---|---|-------|-------------------|--------|--------|--------------|--------|--------------|
|  |  | F4 | 50kA | 315 | 830185 | 30330 | 830195 | 35960 |
| | | F4 | 50kA | 400 | 830186 | 33100 | 830196 | 38840 |
| | | F4 | 50kA | 500 | 830187 | 35990 | 830197 | 41750 |
| | | F4 | 50kA | 630 | 830188 | 38150 | 830198 | 43260 |

830185

830186

Optium 1.0 (Fixed TM MCCB Range)

HSN Code: 8536

| | | Frame | Breaking Capacity | Rating | 3P | MRP ₹ / Unit | 4P | MRP ₹ / Unit |
|---|--|-------|-------------------|--------|--------|--------------|--------|--------------|
|  | | F5 | 50kA | 800 | 830200 | 49710 | 830201 | 64210 |









830200

optium™
ALL THAT YOU NEED
MCCB

Optium 1.1 (Fixed TM MCCB Range)

• Ics = 100% Icu as per IEC 60947-II • Class II Front Face • Suitable for Isolation • Fixed Overload & Fixed Short Circuit Setting

HSN Code: 8536

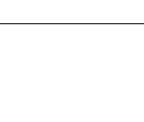
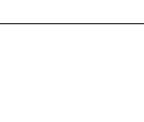
| | Frame | Breaking Capacity | Rating | 3P | MRP ₹ / Unit | 4P | MRP ₹ / Unit |
|---|-------|-------------------|--------|--------|--------------|--------|--------------|
|  | F1 | 16kA | 32 | 840003 | 6010 | 840017 | 7880 |
|  | F1 | 16kA | 40 | 840004 | 6010 | 840018 | 7880 |
|  | F1 | 16kA | 63 | 840006 | 6010 | 840020 | 7880 |
|  | F1 | 16kA | 80 | 840007 | 6240 | 840021 | 8430 |
|  | F1 | 16kA | 100 | 840008 | 6240 | 840022 | 8430 |
|  | F1 | 16kA | 125 | 840009 | 8750 | 840023 | 11760 |
|  | F1 | 25kA | 32 | 840033 | 7290 | 840047 | 9230 |
|  | F1 | 25kA | 40 | 840034 | 7290 | 840048 | 9230 |
|  | F1 | 25kA | 63 | 840036 | 7290 | 840050 | 9230 |
|  | F1 | 25kA | 80 | 840037 | 7720 | 840051 | 9410 |
| | F1 | 25kA | 100 | 840038 | 7720 | 840052 | 9410 |
| | F1 | 25kA | 125 | 840039 | 8930 | 840053 | 13200 |
| | F2 | 16kA | 160 | 840090 | 9250 | 840095 | 13800 |
| | F2 | 16kA | 200 | 840091 | 11620 | 840096 | 15420 |
| | F2 | 16kA | 250 | 840092 | 13240 | 840097 | 17680 |
| | F2 | 25kA | 160 | 840100 | 10770 | 840105 | 14240 |
| | F2 | 25kA | 200 | 840101 | 15120 | 840106 | 18160 |
| | F2 | 25kA | 250 | 840102 | 19540 | 840107 | 24420 |





optium™
ALL THAT YOU NEED
MCCB

Optium 2.0 (Adjustable Thermal Setting MCCB)





• Conforms to IEC 60947-II • Ics = 100% Icu • Class II Front Face • Suitable for Isolation • Adjustable Overload

Setting Ir = (0.8 to 1.0) x In • Short Circuit Setting Fixed

HSN Code: 8536

| Frame | Breaking Capacity | Rating | 3P | MRP ₹ / Unit | 4P | MRP ₹ / Unit | | |
|---|---|--------|------|--------------|--------|--------------|--------|-------|
|  830222 |  830223 | F1 | 16kA | 25 | 830222 | 6110 | 830236 | 8160 |
| | | F1 | 16kA | 32 | 830223 | 6110 | 830237 | 8160 |
| | | F1 | 16kA | 40 | 830224 | 6110 | 830238 | 8160 |
| | | F1 | 16kA | 50 | 830225 | 6110 | 830239 | 8160 |
| | | F1 | 16kA | 63 | 830226 | 6110 | 830240 | 8160 |
|  830224 |  830225 | F1 | 16kA | 80 | 830227 | 6620 | 830241 | 8770 |
| | | F1 | 16kA | 100 | 830228 | 6620 | 830242 | 8770 |
| | | F1 | 16kA | 125 | 830229 | 9050 | 830243 | 12230 |

HSN Code: 8536

| Frame | Breaking Capacity | Rating | 3P | MRP ₹ / Unit | 4P | MRP ₹ / Unit | | |
|---|---|--------|------|--------------|--------|--------------|--------|-------|
|  830252 |  830253 | F1 | 25kA | 25 | 830252 | 7660 | 830266 | 9650 |
| | | F1 | 25kA | 32 | 830253 | 7660 | 830267 | 9650 |
| | | F1 | 25kA | 40 | 830254 | 7660 | 830268 | 9650 |
| | | F1 | 25kA | 50 | 830255 | 7660 | 830269 | 9650 |
| | | F1 | 25kA | 63 | 830256 | 7660 | 830270 | 9650 |
|  830254 |  830255 | F1 | 25kA | 80 | 830257 | 8040 | 830271 | 10120 |
| | | F1 | 25kA | 100 | 830258 | 8040 | 830272 | 10120 |
| | | F1 | 25kA | 125 | 830259 | 9310 | 830273 | 13850 |

optium™
ALL THAT YOU NEED
MCCB

Optium 2.0 (Adjustable Thermal Setting MCCB)

HSN Code: 8536



| Frame | Breaking Capacity | Rating | 3P | MRP ₹ / Unit | 4P | MRP ₹ / Unit |
|-------|-------------------|--------|--------|--------------|--------|--------------|
| F2 | 16kA | 160 | 830280 | 9710 | 830285 | 14290 |
| F2 | 16kA | 200 | 830281 | 12100 | 830286 | 16010 |
| F2 | 16kA | 250 | 830282 | 14000 | 830287 | 18920 |
| F2 | 25kA | 160 | 830290 | 12290 | 830295 | 16120 |
| F2 | 25kA | 200 | 830291 | 15720 | 830296 | 20290 |
| F2 | 25kA | 250 | 830292 | 21020 | 830297 | 26290 |

Optium 2.0 (Adjustable TM MCCB Range)

• Ics =100% Icu as per IEC 60947-II • Class II Front Face • Suitable for Isolation • Adjustable Overload Setting

$I_r = (0.8 \text{ to } 1.0) \times I_n$ • Adjustable Short Circuit Setting $I_{sd} = (5 - 10) \times I_n$

HSN Code: 8536



| Frame | Breaking Capacity | Rating | 3P | MRP ₹ / Unit | 4P | MRP ₹ / Unit |
|-------|-------------------|--------|--------|--------------|--------|--------------|
| F3 | 36kA | 16 | 830305 | 9910 | 830325 | 13700 |
| F3 | 36kA | 25 | 830306 | 9910 | 830326 | 13700 |
| F3 | 36kA | 32 | 830307 | 9910 | 830327 | 13700 |
| F3 | 36kA | 40 | 830308 | 9910 | 830328 | 13700 |
| F3 | 36kA | 50 | 830309 | 9910 | 830329 | 13700 |
| F3 | 36kA | 63 | 830310 | 9910 | 830330 | 13700 |
| F3 | 36kA | 80 | 830311 | 10110 | 830331 | 14100 |
| F3 | 36kA | 100 | 830312 | 10110 | 830332 | 14100 |
| F3 | 36kA | 125 | 830313 | 13110 | 830333 | 15800 |

optium™
ALL THAT YOU NEED
MCCB

Optium 2.0 (Adjustable Thermal Setting MCCB)

HSN Code: 8536



830345



830346

| Frame | Breaking Capacity | Rating | 3P | MRP ₹ / Unit | 4P | MRP ₹ / Unit |
|-------|-------------------|--------|--------|--------------|--------|--------------|
| F3 | 50kA | 16 | 830345 | 13350 | 830365 | 15950 |
| F3 | 50kA | 25 | 830346 | 13350 | 830366 | 15950 |
| F3 | 50kA | 32 | 830347 | 13350 | 830367 | 15950 |
| F3 | 50kA | 40 | 830348 | 13350 | 830368 | 15950 |
| F3 | 50kA | 50 | 830349 | 13350 | 830369 | 15950 |
| F3 | 50kA | 63 | 830350 | 13350 | 830370 | 15950 |
| F3 | 50kA | 80 | 830351 | 13620 | 830371 | 16110 |
| F3 | 50kA | 100 | 830352 | 13620 | 830372 | 16110 |
| F3 | 50kA | 125 | 830353 | 14980 | 830373 | 19230 |

HSN Code: 8536



830314

| Frame | Breaking Capacity | Rating | 3P | MRP ₹ / Unit | 4P | MRP ₹ / Unit |
|-------|-------------------|--------|--------|--------------|--------|--------------|
| F3 | 36kA | 160 | 830314 | 16560 | 830334 | 19710 |
| F3 | 36kA | 200 | 830315 | 18570 | 830335 | 25710 |
| F3 | 36kA | 250 | 830316 | 24400 | 830336 | 33670 |

HSN Code: 8536



830354

| Frame | Breaking Capacity | Rating | 3P | MRP ₹ / Unit | 4P | MRP ₹ / Unit |
|-------|-------------------|--------|--------|--------------|--------|--------------|
| F3 | 50kA | 160 | 830354 | 17160 | 830374 | 21650 |
| F3 | 50kA | 200 | 830355 | 20020 | 830375 | 27450 |
| F3 | 50kA | 250 | 830356 | 28420 | 830376 | 35460 |

optium™
ALL THAT YOU NEED
MCCB

Optium 2.0 (Adjustable Thermal Setting MCCB)

HSN Code: 8536



830385



830386

| Frame | Breaking Capacity | Rating | 3P | MRP ₹ / Unit | 4P | MRP ₹ / Unit |
|-------|-------------------|--------|--------|--------------|--------|--------------|
| F4 | 25kA | 315 | 830385 | 25940 | 830387 | 32670 |
| F4 | 25kA | 400 | 830386 | 26560 | 830388 | 35640 |
| F4 | 36kA | 315 | 830390 | 31170 | 830395 | 37970 |
| F4 | 36kA | 400 | 830391 | 33160 | 830396 | 40880 |
| F4 | 36kA | 500 | 830392 | 39030 | 830397 | 47920 |
| F4 | 36kA | 630 | 830393 | 41990 | 830398 | 53690 |
| F4 | 50kA | 315 | 830400 | 33290 | 830405 | 41110 |
| F4 | 50kA | 400 | 830401 | 35520 | 830406 | 43170 |
| F4 | 50kA | 500 | 830402 | 40690 | 830407 | 50620 |
| F4 | 50kA | 630 | 830403 | 43990 | 830408 | 56150 |

Optium 2.0 (Adjustable Thermal Setting MCCB)

HSN Code: 8536



830410

| Frame | Breaking Capacity | Rating | 3P | MRP ₹ / Unit | 4P | MRP ₹ / Unit |
|-------|-------------------|--------|--------|--------------|--------|--------------|
| F5 | 36kA | 800 | 830410 | 51300 | 830413 | 62910 |
| F5 | 36kA | 1000 | 830411 | 73890 | 830414 | 84520 |
| F5 | 36kA | 1250 | 830412 | 85460 | 830415 | 101560 |
| F5 | 50kA | 800 | 830416 | 52820 | 830419 | 75250 |
| F5 | 50kA | 1000 | 830417 | 91860 | 830420 | 98500 |
| F5 | 50kA | 1250 | 830418 | 101310 | 830421 | 114090 |

optium™
ALL THAT YOU NEED
MCCB

Accessories

HSN Code: 8538



830691

| Product | Frame | Cat Ref | MRP ₹ / Unit |
|-------------------------------|----------|---------|--------------|
| AUXILIARY CONTACT F1 F2 F3 | F1 F2 F3 | 830691 | 1400 |
| ALARM CONTACT F1 F2 F3 | F1 F2 F3 | 830692 | 1400 |
| AUXILIARY/ALARM CONTACT F4 F5 | F4-F5 | 830693 | 1780 |
| AUX./ALARM CONTACT F1 F2 F3 | F1 F2 F3 | 830694 | 2100 |

HSN Code: 8538



830602

| Product | Frame | Cat Ref | MRP ₹ / Unit |
|--------------------------------|----------|---------|--------------|
| SHUNT TRIP 24V AC/DC F1 F2 F3 | F1 F2 F3 | 830602 | 1590 |
| SHUNT TRIP 110V AC/DC F1 F2 F3 | F1 F2 F3 | 830603 | 1590 |
| SHUNT TRIP 230V AC/DC F1 F2 F3 | F1 F2 F3 | 830604 | 1700 |
| SHUNT TRIP 415V AC/DC F1 F2 F3 | F1 F2 F3 | 830605 | 1700 |
| SHUNT TRIP 24V AC/DC F4 F5 | F4 F5 | 830642 | 3020 |
| SHUNT TRIP 110V AC/DC F4 F5 | F4 F5 | 830643 | 3020 |
| SHUNT TRIP 230V AC/DC F4 F5 | F4 F5 | 830644 | 3020 |
| SHUNT TRIP 415V AC/DC F4 F5 | F4 F5 | 830645 | 3020 |

HSN Code: 8538



830606

| Product | Frame | Cat Ref | MRP ₹ / Unit |
|-------------------------------|----------|---------|--------------|
| UNDERVOLTAGE 24 V DC F1 F2 F3 | F1 F2 F3 | 830606 | 2610 |
| UNDERVOLTAGE 110V AC F1 F2 F3 | F1 F2 F3 | 830607 | 2610 |
| UNDERVOLTAGE 230V AC F1 F2 F3 | F1 F2 F3 | 830608 | 2610 |
| UNDERVOLTAGE 415V AC F1 F2 F3 | F1 F2 F3 | 830609 | 2610 |
| UNDERVOLTAGE 24 V DC F4 F5 | F4 F5 | 830646 | 2690 |
| UNDERVOLTAGE 110V AC F4 F5 | F4 F5 | 830647 | 2690 |
| UNDERVOLTAGE 230V AC F4 F5 | F4 F5 | 830648 | 2690 |
| UNDERVOLTAGE 415V AC F4 F5 | F4 F5 | 830649 | 2690 |

optium™
ALL THAT YOU NEED
MCCB

Accessories

HSN Code: 8538



830611



830626

| Product | Frame | Cat Ref | MRP ₹ / Unit |
|--------------------------|-------|---------|--------------|
| Rotary Handle Direct | F1 | 830611 | 2000 |
| Rotary Handle vary-Depth | F1 | 830612 | 2000 |
| Rotary Handle Direct | F2 F3 | 830626 | 2270 |
| Rotary Handle vary-Depth | F2 F3 | 830627 | 2270 |
| Rotary Handle Direct | F4 | 830651 | 2690 |
| Rotary Handle vary-Depth | F4 | 830652 | 2690 |
| Rotary Handle Direct | F5 | 830671 | 5260 |
| Rotary Handle vary-Depth | F5 | 830672 | 5260 |

HSN Code: 8538



830613

| Product | Frame | Cat Ref | MRP ₹ / Unit |
|--------------------------|----------|---------|--------------|
| Ronis lock Direct RH | F1 F2 F3 | 830613 | 2190 |
| Ronis lock Vary-Depth RH | F1 F2 F3 | 830614 | 2190 |
| Ronis lock Vary-Depth RH | F4 | 830653 | 2860 |

HSN Code: 8538



830615

| Product | Frame | Cat Ref | MRP ₹ / Unit |
|----------------------|----------|---------|--------------|
| Padlock Off position | F1 F2 F3 | 830615 | 2980 |
| Padlock Off position | F4 | 830654 | 2880 |
| Padlock Off position | F5 | 830674 | 2880 |

optium™
ALL THAT YOU NEED
MCCB

Accessories

HSN Code: 8538



830616





830628

| Product | Frame | Cat. Nos. | MRP ₹ / Unit |
|--------------------------|-------|-----------|--------------|
| PHASE INSULATOR 3P F1 F2 | F1 F2 | 830616 | 470 |
| PHASE INSULATOR 3P F3 | F3 | 830628 | 560 |
| PHASE INSULATOR 3P F4 | F4 | 830655 | 980 |
| PHASE INSULATOR 3P F5 | F5 | 830675 | 1330 |
| PHASE INSULATOR 4P F1 F2 | F1 F2 | 830617 | 710 |
| PHASE INSULATOR 4P F3 | F3 | 830629 | 700 |
| PHASE INSULATOR 4P F4 | F4 | 830656 | 1200 |
| PHASE INSULATOR 4P F5 | F5 | 830676 | 1570 |

Accessories

HSN Code: 8538

| | Product | Frame | Cat. Nos. | MRP ₹ / Unit |
|---|------------------------|-------|-----------|--------------|
|  <p>830618</p> | Spreaders 3P | F1 | 830618 | 540 |
| | Spreaders 4P | F1 | 830619 | 790 |
|  <p>830619</p> | Spreaders 3P | F2 F3 | 830632 | 1350 |
| | Spreaders 4P | F2 F3 | 830633 | 2700 |
| | Spreaders 3P | F4 | 830659 | 4280 |
| | Spreaders 4P | F4 | 830660 | 6240 |
| | Spreaders 3P 800/1000A | F5 | 830681 | 11050 |
| | Spreaders 4P 800/1000A | F5 | 830682 | 16770 |
| | Spreaders 3P 1250A | F5 | 830685 | 11500 |
| | Spreaders 4P 1250A | F5 | 830686 | 16950 |

Switch on to a reliable partner

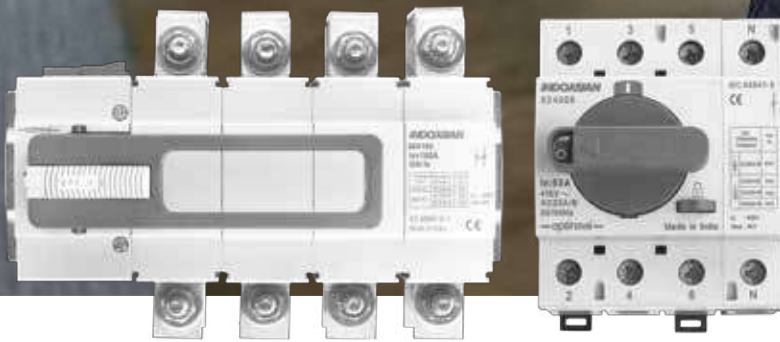

Scan to know more about the product

Optinova provides low-voltage switch disconnectors and transfer switching solutions for safe circuit isolation and reliable power changeover in buildings, industries, and infrastructure.

Features

- Clear indication of mechanism with rotary handles and a padlock for safety
- IP20 protected internal mechanism with DIN-rail or plate mounting options
- High short-time withstand capacity (Icw) and ratings up to 320 A

Benefits

- Simplifies installation & maintenance with compact form factor & snap-fit auxiliaries
- Ensures safe isolation and source changeover, reducing risk of accidents
- Delivers high reliability & uptime through robust design & high short-time withstand ratings

— optinova™ —

**4P Switch Disconnecter / Transfer Switching
Equipment - DIN Frame**

HSN Code: 8536



824006

| Rated Current | Cat Ref. | Description | MRP ₹ / Unit |
|---------------|----------|-----------------------|--------------|
| 32A | 824006 | SD DIN OPTI 63 4P 32A | 2640 |
| 40A | 824007 | SD DIN OPTI 63 4P 40A | 2790 |
| 63A | 824008 | SD DIN OPTI 63 4P 63A | 3310 |

**4P Switch Disconnecter / Transfer Switching
Equipment - Power Frame**

HSN Code: 8536



824082

| Rated Current | Cat Ref. | Description | MRP ₹ / Unit |
|---------------|----------|----------------------------------|--------------|
| 63A | 824082 | SD PLATE OPTI 160 4P 63A KIT | 4610 |
| 100A | 824083 | SD PLATE OPTI 160 4P 100A KIT | 6430 |
| 125A | 824084 | SD PLATE OPTI 160 4P 125A KIT | 6950 |
| 160A | 824085 | SD PLATE OPTI 160 4P 160A KIT | 8810 |
| 200A | 824086 | SD PLATE OPTI 320 4P 200A KIT | 11020 |
| 250A | 824087 | SD PLATE OPTI 320 4P 250A KIT | 13840 |
| 320A | 824088 | SD PLATE OPTI 320 4P 320A KIT | 15370 |

**4P Switch Disconnecter / Transfer Switching
Equipment - DIN Frame**

HSN Code: 8536



824106

| Rated Current | Cat Ref. | Description | MRP ₹ / Unit |
|---------------|----------|------------------------|--------------|
| 32A | 824106 | TSE DIN OPTI 63 4P 32A | 4980 |
| 40A | 824107 | TSE DIN OPTI 63 4P 40A | 5570 |
| 63A | 824108 | TSE DIN OPTI 63 4P 63A | 6210 |

— optinova™ —

**4P Switch Disconnecter / Transfer Switching
Equipment - Power Frame**

HSN Code: 8536



824182

| Rated Current | Cat Ref. | Description | MRP ₹ / Unit |
|---------------|----------|--------------------------------|--------------|
| 63A | 824182 | TSE PLATE OPTI 160 4P 63A KIT | 7240 |
| 100A | 824183 | TSE PLATE OPTI 160 4P 100A KIT | 9010 |
| 125A | 824184 | TSE PLATE OPTI 160 4P 125A KIT | 13520 |
| 160A | 824185 | TSE PLATE OPTI 160 4P 160A KIT | 15070 |
| 200A | 824186 | TSE PLATE OPTI 320 4P 200A KIT | 18010 |
| 250A | 824187 | TSE PLATE OPTI 320 4P 250A KIT | 25760 |
| 320A | 824188 | TSE PLATE OPTI 320 4P 320A KIT | 27440 |

**4P Switch Disconnecter / Transfer Switching
Equipment - Power Frame**

HSN Code: 8536



824192

| Rated Current | Cat Ref. | Description | MRP ₹ / Unit |
|---------------|----------|--------------------------------|--------------|
| 63A | 824192 | TSE PLATE OPTI 160 4P 63A ENC | 10540 |
| 100A | 824193 | TSE PLATE OPTI 160 4P 100A ENC | 13780 |
| 125A | 824194 | TSE PLATE OPTI 160 4P 125A ENC | 19360 |
| 160A | 824195 | TSE PLATE OPTI 160 4P 160A ENC | 21280 |
| 200A | 824196 | TSE PLATE OPTI 320 4P 200A ENC | 24740 |
| 250A | 824197 | TSE PLATE OPTI 320 4P 250A ENC | 32940 |
| 320A | 824198 | TSE PLATE OPTI 320 4P 320A ENC | 35510 |

— optinova™ —

Accessories - DIN Frame

HSN Code: 8538



824201

| Product | Cat Ref. | Description | MRP ₹ / Unit |
|--|----------|-------------------------------|--------------|
| Shorting links 63A for TSE | 824201 | OPTI Shorting links F1 4P DIN | 950 |
| Auxiliary contact Simultaneous (1 NO + 1 NC) | 824208 | OPTI Auxcont 1No+1NC F1&2 DIN | 500 |
| Handle Vary Depth KIT IP54 | 824209 | OPTI Handle Depth KIT F1&2DIN | 1400 |
| SD Direct Handle | 824215 | OPTI Handle Direct F1&2 DIN | 1120 |
| TSE Direct Handle | 824217 | OPTI TSE Handle Dir F1&2DIN | 1120 |

Accessories - Frame 2- 320A

HSN Code: 8538



824230

| Product | Cat Ref. | Description | MRP ₹ / Unit |
|--|----------|--------------------------------|--------------|
| Handle Direct | 824230 | OPTI Handle Direct | 1170 |
| Handle Vary Depth | 824231 | OPTI Handle Vary Depth | 1670 |
| Spreader terminals (one side only) | 824238 | OPTI Sprdter termi F2 4P_1Side | 2180 |
| Inter source barrier for TSE | 824239 | OPTI Intersourcebar F2(3P&4P) | 450 |
| Shorting Link for TSE | 824241 | OPTI Linking bridge-4P | 4010 |
| Phase Barriers | 824243 | OPTI Phase Barriers F2 4P | 280 |
| Aux contact Simultaneous (4 NO + 4 NC) | 824245 | OPTI Auxcontact SimulTan F1&2 | 1400 |

Accessories - Frame 1- 160A

HSN Code: 8538



824249

| Product | Cat Ref. | Description | MRP ₹ / Unit |
|------------------------------------|----------|--------------------------------|--------------|
| Shorting Link for TSE | 824249 | OPTI Linking bridge-4P | 2680 |
| Phase Barriers | 824251 | OPTI Phase Barriers F1 4P | 220 |
| Inter source barrier for TSE | 824252 | OPTI Intersourcebar F1(3P&4P) | 280 |
| Spreader terminals (one side only) | 824254 | OPTI Sprdter termi F1 4P-1Side | 1090 |

— optinova™ —

HRC Fuse Links & Bases

Bolted Type (BS) Breaking Capacity $\geq 80\text{kA}$ 500 V AC 50 Hz.

HSN Code: 8536



| Rating | Type | Cat Ref. | Tag Type | MRP ₹ / Unit | Unit/Carton |
|------------------------------------|-------|----------|-----------|--------------|-------------|
| 2, 4, 6, 8, 10, 16A | FGN | IEFGN*** | Offset | 110 | 20 |
| 2, 4, 6, 10, 16, 20, 25, 32A | FSA | IEFSA*** | Offset | 170 | 10 |
| 35, 40, 50, 63A | FSS | IEFSS*** | Offset | 190 | 10 |
| 50, 63, 80, 100, 125, 160A | FSDCP | IEDCP*** | Offset | 410 | 10 |
| 100, 125, 160, 200, 250A | FSFP | IESFP*** | Offset | 580 | 3 |
| 50, 63, 80, 100, 125A | FSDC | IESDC*** | Offset | 410 | 10 |
| 100, 125, 160, 200, 250A | FSF | IEFSF*** | Central | 600 | 3 |
| 225, 250, 300, 315, 320A | FSK | IEFSK*** | Central | 860 | 3 |
| 355, 400A | FMF | IEFMF*** | Central | 1660 | 3 |
| 355, 400, 450, 500, 560, 600, 630A | FTS | IEFTS*** | Central | 1920 | 1 |
| 355, 400, 450, 500, 560A | FTM | IEFTM*** | Central | 2480 | 1 |
| 600, 630A | FTM | IEFTM*** | 2 Central | 2480 | 1 |

DIN Type Breaking Capacity $\geq 80\text{kA}$ 500 V AC 50 Hz.

HSN Code: 8536



| Rating | Type | Cat Ref. | Tag Type | MRP ₹ / Unit | Unit/Carton |
|--|----------|----------|----------|--------------|-------------|
| 2, 4, 6, 10, 16, 20, 25, 32, 50, 63A | Size 000 | IWS00*** | 6 | 510 | 6 |
| 2, 4, 6, 10, 16, 20, 25, 32, 36, 40, 50, 63A | Size 00 | IW000*** | 6 | 119 | 6 |
| 80, 100A | | IW000*** | 6 | 119 | 6 |
| 125, 160A | | IW000*** | 6 | 119 | 6 |
| 32, 36, 50, 63, 80, 100, 125, 160, 200A | Size 01 | IW001*** | 3 | 130 | 3 |
| 250A | | IW001*** | 3 | 130 | 3 |
| 100, 125, 160, 200, 250, 315A | Size 02 | IW002*** | 3 | 1450 | 3 |
| 400A | | IW002*** | 3 | 1450 | 3 |
| 315, 355, 400, 425A | Size 03 | IW003*** | 3 | 1990 | 3 |
| 500, 630A | | IW003*** | 3 | 1990 | 3 |

*HRC fuses with SC breaking capacity 120kA are available on request.

— optinova™ —

Cylindrical Type (IFRH) Breaking Capacity > 80kA 415 V AC.

HSN Code: 8536

| | Rating Amps | Cat Ref. | MRP ₹ / Unit |
|---|--------------------------------|----------|--------------|
|  | 2 to 25A | IFRH0*** | 220 |
| | 32 to 40A | IFRH0*** | 220 |
| | 50A | IFRH0050 | 420 |
| | 63A | IFRH0063 | 430 |
| | Fuse Holder Fr type (2 to 63A) | IFR00*** | 400 |

Fuse Fittings For Bolted (BS) Type

HSN Code: 8536

| | Rating Amps | Front Connection | MRP ₹ / Unit |
|--|-------------|------------------|--------------|
| | 20A | BFBC0020 | 260 |
| | 32A | BFBC0032 | 440 |
| | 63A | BFBC0063 | 650 |
| | 100A | BFBC0100 | 1620 |

Bolted Type (BS) Breaking Capacity ≥ 80kA 500 V AC 50 Hz.

HSN Code: 8536

| | Rating | Type | Cat Ref. | MRP ₹ / Unit | Unit/Carton |
|---|----------|-----------|----------|--------------|-------------|
|  | 6-160A | Size - 00 | IWFB0*** | POR** | 6 |
| | 32-250A | Size - 1 | IWFB1*** | 1320 | 2 |
| | 100-400A | Size - 2 | IWFB2*** | 1980 | 2 |
| | 315-630A | Size - 3 | IWFB3*** | 2510 | 2 |

**POR - Price on Request

— optinova™ —

Switch Disconnecter Fuses

HSN Code: 8536



| Rated Current | Type | IN OPEN EXECUTION* | | IN SHEET STEEL ENCLOSURE | | Recommended HRC Fuse IndoAsian Make |
|---------------|------|--------------------|--------------|--------------------------|--------------|-------------------------------------|
| | | Cat Ref. | MRP ₹ / Unit | Cat Ref. | MRP ₹ / Unit | |
| 32A BS | TPN | INO1A032 | 2630 | INS1A032 | 5370 | FSA |
| 63A BS | TPN | INO1A063 | 3640 | INS1A063 | 6850 | FSS |
| 100A BS | TPN | INO1A100 | 8010 | INS1A100 | 11210 | FSDCP |
| 125A BS | TPN | INO1A125 | 8990 | INS1A125 | 13430 | FSDCP |
| 160A BS | TPN | INO1A160 | 10880 | INS1A160 | 15000 | FSDCP |
| 200A BS | TPN | INO1A200 | 13540 | INS1A200 | 17440 | FSF |
| 250A BS | TPN | INO1A250 | 15280 | INS1A250 | 20170 | FSF |
| 315A BS | TPN | INO1A315 | 19580 | INS1A315 | 25180 | FSK |
| 400A BS | TSPN | INO1A400 | 24300 | INS1A400 | 30050 | FMF |
| 32A BS | TSPN | INO1B032 | 3350 | INS1B032 | 5670 | FSA |
| 63A BS | TSPN | INO1B063 | 4250 | INS1B063 | 6700 | FSS |
| 100A BS | TSPN | INO1B100 | 9850 | INS1B100 | 12550 | FSDCP |
| 125A BS | TSPN | INO1B125 | 10790 | INS1B125 | 13430 | FSDCP |
| 160A BS | TSPN | INO1B160 | 13490 | INS1B160 | 17360 | FSDCP |
| 200A BS | TSPN | INO1B200 | 15360 | INS1B200 | 19210 | FSF |
| 250A BS | TSPN | INO1B250 | 16750 | INS1B250 | 21560 | FSF |
| 315A BS | TSPN | INO1B315 | 23700 | INS1B315 | 30120 | FSK |
| 400A BS | TSPN | INO1B400 | 28040 | INS1B400 | 31330 | FMF |

*Price does not include HRC Fuse

— optinova™ —

Switch Disconnecter Fuses

HSN Code: 8536



| Rated Current | Type | IN OPEN EXECUTION* | | IN SHEET STEEL ENCLOSURE | | Recommended HRC Fuse IndoAsian Make |
|---------------|------|--------------------|--------------|--------------------------|--------------|-------------------------------------|
| | | Cat Ref. | MRP ₹ / Unit | Cat Ref. | MRP ₹ / Unit | |
| 32A DIN | TPN | IN1OA032 | 2770 | IN1SA032 | 5110 | Size 000 |
| 63A DIN | TPN | IN1OA063 | 2770 | IN1SA063 | 6500 | Size 000 |
| 100A DIN | TPN | IN1OA100 | 8210 | IN1SA100 | 11080 | Size 00 |
| 125A DIN | TPN | IN1OA125 | 9380 | IN1SA125 | 13390 | Size 00 |
| 160A DIN | TPN | IN1OA160 | 11290 | IN1SA160 | 14710 | Size 00 |
| 200A DIN | TPN | IN1OA200 | 14100 | IN1SA200 | 16740 | Size 01 |
| 250A DIN | TPN | IN1OA250 | 15790 | IN1SA250 | 20150 | Size 01 |
| 315A DIN | TPN | IN1OA315 | 20280 | IN1SA315 | 25090 | Size 02 |
| 400A DIN | TPN | IN1OA400 | 25000 | IN1SA400 | 29740 | Size 02 |
| 630A DIN | TPN | IN1OA630 | 39380 | IN1SA630 | 42410 | Size 03 |
| 800A DIN | TPN | IN1OA800 | 48020 | IN1SA800 | 60040 | Size 03 |
| 32A DIN | TSPN | IN1OB032 | 3920 | IN1SB032 | 5260 | Size 000 |
| 63A DIN | TSPN | IN1OB063 | 4520 | IN1SB063 | 5680 | Size 000 |
| 100A DIN | TSPN | IN1OB100 | 10130 | IN1SB100 | 11340 | Size 00 |
| 125A DIN | TSPN | IN1OB125 | 11220 | IN1SB125 | 12200 | Size 00 |
| 160A DIN | TSPN | IN1OB160 | 13150 | IN1SB160 | 16310 | Size 00 |
| 200A DIN | TSPN | IN1OB200 | 15280 | IN1SB200 | 17210 | Size 01 |
| 250A DIN | TSPN | IN1OB250 | 17500 | IN1SB250 | 19720 | Size 01 |
| 315A DIN | TSPN | IN1OB315 | 23430 | IN1SB315 | 26830 | Size 02 |
| 400A DIN | TSPN | IN1OB400 | 27230 | IN1SB400 | 33500 | Size 02 |
| 630A DIN | TSPN | IN1OB630 | 43710 | IN1SB630 | 45820 | Size 03 |
| 800A DIN | TSPN | IN1OB800 | 50540 | IN1SB800 | 66040 | Size 03 |

*Price does not include HRC Fuse

Ambidex

Switch Disconnecter Fuses

HSN Code: 8536

| Rated Current | IN OPEN EXECUTION* | | IN SHEET STEEL ENCLOSURE | |
|---------------|--------------------|--------------|--------------------------|--------------|
| | Cat Ref. | MRP ₹ / Unit | Cat Ref. | MRP ₹ / Unit |
| 400A | IN1SD400 | 19930 | IN3ED400 | 31520 |
| 630A | IN1SD630 | 27650 | IN4ED630 | 45980 |
| 800A | IN1SD800 | 32930 | IN4ED800 | 53260 |

Changeover Switches

On-Load Changeover Switches 4 Pole

HSN Code: 8536

| Rated Current | IN OPEN EXECUTION* | | IN SHEET STEEL ENCLOSURE | |
|---------------|--------------------|--------------|--------------------------|--------------|
| | Cat Ref. | MRP ₹ / Unit | Cat Ref. | MRP ₹ / Unit |
| 400A | ICAE0400 | 42060 | ICAS0400 | 66070 |
| 630A | ICAE0630 | 49550 | ICAS0630 | 70800 |
| 800A | ITAE0800 | 69440 | ITAS0800 | 104220 |
| 1000A | ITAE1000 | 125610 | ITAS1000 | 174680 |
| 1250A | ITAE1250 | 168570 | ITAS1250 | 241150 |
| 1600A | ITAE1600 | 193570 | ITAS1600 | 319980 |
| 2000A | ITAE2000 | 283060 | ITAS2000 | 394250 |
| 2500A | ITAE2500 | 389430 | ITAS2500 | 522950 |
| 3150A | ITAE3150 | 400230 | ITAS3150 | 678870 |



Ambidex

Changeover Switches

On-Load Changeover Switches 4 Pole

HSN Code: 8536

| Rating Amps | Cat Ref. | MRP ₹ / Unit |
|-------------------------------|----------|--------------|
| Aux.Switch 200A-630A(1NO+1NC) | ICA00AUX | 290 |
| SPREADER LINK FRAME00-4 LINKS | ICA00SPL | 460 |

On-Load Switch Fuse Changeover

HSN Code: 8536

| Rated Current | IN OPEN EXECUTION* | | IN SHEET STEEL ENCLOSURE | |
|---------------|--------------------|--------------|--------------------------|--------------|
| | Cat Ref. | MRP ₹ / Unit | Cat Ref. | MRP ₹ / Unit |
| 125A | ITBE0125 | 19610 | ITBS0125 | 29970 |
| 200A | ITBE0200 | 35830 | ITBS0200 | 53200 |
| 250A | ITBE0250 | 36170 | ITBS0250 | 53700 |
| 320A | ITBE0320 | 37340 | ITBS0320 | 55440 |
| 400A | ITBE0400 | 54090 | ITBS0400 | 80300 |
| 630A | ITBE0630 | 63130 | ITBS0630 | 93720 |



*Price does not include HRC Fuse

On-Load By-Pass Switches

HSN Code: 8536

| Rated Current | IN OPEN EXECUTION* | | IN SHEET STEEL ENCLOSURE | |
|---------------|--------------------|--------------|--------------------------|--------------|
| | Cat Ref. | MRP ₹ / Unit | Cat Ref. | MRP ₹ / Unit |
| 125A | ITCE0125 | 27900 | ITCS0125 | 37670 |
| 200A | ITCE0200 | 35530 | ITCS0200 | 47960 |
| 250A | ITCE0250 | 51610 | ITCS0250 | 69680 |
| 320A | ITCE0320 | 53590 | ITCS0320 | 72350 |
| 400A | ITCE0400 | 80390 | ITCS0400 | 108530 |
| 630A | ITCE0630 | 91330 | ITCS0630 | 123300 |

*Price does not include HRC Fuse

Ambidex

Off Load Changeover Switch

HSN Code: 8536



- With enclosure
- Rated Voltage - 415V-AC 50Hz
- Type - FP

| Rating | Cat Ref. | MRP ₹ / Unit |
|----------|----------|--------------|
| 32A (DP) | OFDP0032 | 2530 |
| 16A | OFFP0016 | 4050 |
| 32A | OFFP0032 | 4230 |
| 63A | OFFP0063 | 8590 |
| 100A | OFFP0100 | 16780 |
| 125A | OFFP0125 | 23590 |
| 200A | OFFP0200 | 25470 |
| 250A | OFFP0250 | 32450 |
| 315A | OFFP0315 | 33500 |
| 400A | OFFP0400 | 39080 |

*Prices for spares of Rewirable Switch Fuse Unit like Action Bar, Base Plate, End Shield, Bakelite Contact Shrouds are available on request.

GENERAL TERMS

- This price list supersedes all previous price lists.
- All prices are in Indian Rupees only.
- All prices are Maximum Retail Prices (MRP) inclusive of GST as applicable.
- Our discount structure is exclusive of GST
- Orders will be accepted in multiples of standard packing.
- Prices are subject to change without notice. All despatches will be as per prices prevailing on the date of despatch. Prices are ex-godown, exclusive of packing/forwarding/freight and insurance.
- Product design is subject to change without notice for continuous up gradation.
- Disputes if any are subject to Delhi Jurisdiction only.
- Company reserves the right to issue amendments which may arise due to any printing errors in the price list.

WARRANTY

IA products carry a warranty against manufacturing defects, subject to use of the product for the right application, with correct wiring/connection and normal operating conditions. Please refer to detailed IndoAsian warranty policy effective 1st Jan 2026.

| | |
|--|------------|
| MCBs | 36 Months |
| RCCBs | 36 Months |
| DBs/ACCL | 12 Months |
| HRC Fuses | 6 Months |
| MCCBs/BFF/Fuse Bases/Changeover Switchgears/SDF | 12 Months |
| Time Switches | 12 Months |
| For Wiring Devices - Switches & Socket | 120 Months |
| Bulb Holder/Ceiling Rose | 12 Months |
| For Wiring Devices - Electronic Products (e.g. Fan Regulator, Dimmer, Buzzer, RJ45, RJ11 & TV Sockets, Bell Indicator, Motor starter, Skirting light) | 24 Months |

CHANNEL PARTNER

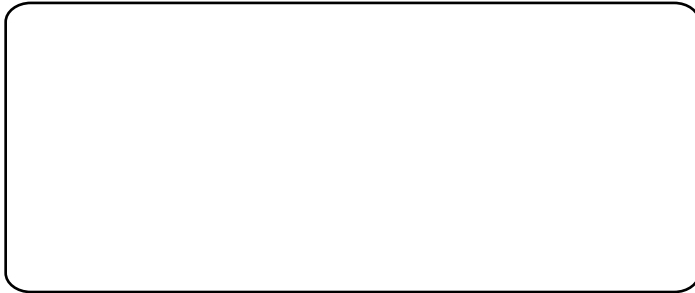

CORPORATE OFFICE: V. J. Business Towers, A-6, 1st Floor, Sector-125, Noida-201301, U.P., India.

CORPORATE OFFICE: V. J. Business Towers, A-6, 1st Floor, Sector-125, Noida-201301, U.P., India. Ph.: +91-0120-3305111 E-mail: customer.care@indoasian.com, international@indoasian.com Website: www.indoasian.com

CUSTOMER CARE HEAD: Novateur Electrical & Digital Systems Pvt. Ltd., V. J. Business Towers, A-6, 1st Floor, Sector-125, Noida-201301, U.P., India. Ph.: +91-0120-3305100 Toll Free no. 1800 103 7077 E-mail: customer.care@indoasian.com

NORTH

**Regional Sales office
DELHI NCR**
V. J. Business Towers
A-6, Ground Floor,
Sector-125, Noida-201303
Ph.: 0120-6858900

**Branch office
CHANDIGARH**
SCO No. 6, 2nd Floor,
Madhya Marg, Sector 26,
Chandigarh-160019

**Branch office
JAIPUR**
433, 4th Floor, Ganpati Plaza,
M. I. Road,
Jaipur-302001
Ph.: 0141-4113528

**Branch office
LUCKNOW**
107 B&C, 1st Floor, Ratan Square
20-A Vidhan Sabha Marg,
Lucknow-226001
Ph.: 0522-4013210

SOUTH

**Regional Sales office
BANGALORE**
787, 1st Floor "Skyline Vista" 15th Cross,
100 Feet Ring Road, J P Nagar 1st Phase,
Bangalore-560 078
Tel: 080-46219999
E-Mail: in-bangalore-office@indoasian.com

**Branch office
COCHIN**
Door No.65/1317, Syda Building, 2nd Floor,
Kaloor-Kadavanthra Road, Kaloor,
Ernakulam District, Kochi-682017 (Kerala)
Ph.: 0484-4055581-88
E-Mail: in-cochin-office@indoasian.com

**Branch office
COIMBATORE**
Door No. 83,
Dr. Nanjappa Road,
Coimbatore-641018
Ph.: 0422-2302715
E-Mail: in-coimbatore-office@indoasian.com

**Branch office
CHENNAI**
No.5, 1st Floor, Mahalingapuram Main Road,
Nungambakkam,
Chennai-600034
Ph.: 044-28172096, 28170527
E-Mail: in-chennai-office@indoasian.com

**Branch office
HYDERABAD**
312, 3rd Floor,
Amrutha Estates, Himayath Nagar,
Hyderabad-500029
Ph.: 040-66742425
E-Mail: in-secunderabad-office@indoasian.com

WEST

**Regional Sales office
MUMBAI**
401 & 408, K.P. Arrum,
Marol Maroshi Road, Andheri East,
Mumbai-400059
Ph.: 022-61035800
E-Mail: in-mumbai-office@indoasian.com

**Branch office
AHMEDABAD**
102, 1st Floor, Shivalik High Street,
Near Mansi Circle, Vastrapur,
Ahmedabad-380015
Ph.: 079-29701351-53
E-Mail: in-ahmedabad-office@indoasian.com

**Branch office
INDORE**
Tower B, 403 - The One
Ravindra Nath Tagore Marg,
Indore- 452001
Ph.: 0731-4677510
E-Mail: in-indore-office@indoasian.com

**Branch office
PUNE**
311, Pride Silicon Plaza, Bhamburda,
Shivaji Nagar, Senapati Bapat Marg,
Pune-411016
Ph.: 8087610722
E-Mail: in-pune-office@indoasian.com

EAST

**Regional Sales office
KOLKATA**
"Raikva Building" Room No. 8, 2nd Floor,
3A Ram Mohan Garden Lane, Beliaghata E.M.Bypass,
Kolkata-700010
Ph.: 033-66041503
E-Mail: in-kolkata-office@indoasian.com