



## ABOUT US

IndoAsian, an Indian-origin brand **established in 1958**, has been a pioneer in electrical safety and innovation, trusted for delivering reliable, high quality solutions that empower homes, businesses, and communities.

With industry leading milestones such as introducing **6kA MCBs and RCCBs in India**, the brand has consistently set new standards in protection and performance. Its association with Group Legrand India further strengthened its innovation capabilities and expanded its reach, allowing IndoAsian to offer world class electrical and digital infrastructure.

Guided by the motto “**Enriching quality of life by ensuring safe, efficient and convenient use of electricity,**” the brand continues to uphold strong values, customer first innovation, and ethical, sustainable practices focused on **renewable energy and reducing environmental impact.**



# CONTENT

<b>Shynora</b> WIRING ACCESSORIES .....	04-17
<b>Glint™</b> WIRING ACCESSORIES .....	18-24
<b>ELVIRA</b> WIRING ACCESSORIES .....	25-31
<b>Doorsta</b> DING DONG DOORBELL .....	32-33
<b>PL9 PLUGS</b> .....	33
<b>Zosta™</b> EXHAUST FANS .....	34-35
<b>BULB HOLDER / CEILING ROSE</b> .....	36-37
<b>Caretron™</b> MINIATURE CIRCUIT BREAKER (MCBS) .....	38-42
<b>Caretron™</b> ISOLATOR .....	43
<b>Caretron™</b> RESIDUAL CURRENT CIRCUIT BREAKER (RCCBS) .....	44
—optipro— MINIATURE CIRCUIT BREAKER (MCBS) .....	45-46
—optipro— ISOLATOR .....	47
<b>AUTOMATIC CHANGEOVER WITH CURRENT LIMITER (ACCL)</b> .....	48
<b>Caretron™</b> DISTRIBUTION BOARDS (DBS) .....	49-53
<b>BUSBAR CHAMBER</b> .....	54-55
<b>TIME SWITCHES</b> .....	56
—optium— MCCB - 1.0 (FIXED TM RANGE) .....	57-61
—optium— MCCB - 1.1 (FIXED TM RANGE) .....	62
—optium— MCCB - 2.0 (ADJUSTABLE TM RANGE) .....	63-66
—optium— MCCB ACCESSORIES .....	67-70
—optinova— SWITCH DISCONNECTOR / TSE (ON LOAD CHANGEOVER) .....	71-74
<b>HRC FUSE LINKS &amp; BASES</b> .....	75-76
<b>SWITCH DISCONNECTOR FUSES</b> .....	77-78
<b>Ambidex</b> CHANGEOVER SWITCHES .....	79-81

## Add a touch of shine to your life



**Shynora** provides modular wiring device range blending elegant design with functionality for homes and commercial spaces.

Scan to know more about the product

### Features

- Switches tested for up to 1 lakh on/off operations along with safety shuttered sockets
- Complete range of electronics, hospitality solutions and fast USB charging options (Type C 20W PD)
- High grade flame retardant polycarbonate material with laser etched markings
- Ranges tested for best-in-class quality with ISI, CRS & RoHS certification

### Benefits

- Delivers long term value through high cycle durability testing
- Stylish design enhancing living spaces aesthetically
- Modular design offering flexibility & durability
- Assured quality with safety compliance and dependable performance



# Shynora

## Mechanisms White

**Switches:** • Polycarbonate Material • LED Based Indicator • Shrouded Terminal • ISI Marked



### Switches 6A 230 V AC

**HSN Code: 8536**

			Cat. Nos.	Description	Module	MRP ₹ / Unit	Pack
 810600  810604  810605	810600	6A 1 way Switch	1	48	1/20/400		
	810610	6A 2 way Switch	1	100	1/20/200		
	810602	6A 1 way Switch with Indicator	1	102	1/20/200		
	810604	6A 1 way Switch with "Light" Marking	1	102	1/20/200		
	810605	6A 1 way Switch with "Fan" Marking	1	102	1/20/200		



### Switches 10A 230 V AC

**HSN Code: 8536**

			Cat. Nos.	Description	Module	MRP ₹ / Unit	Pack
 810673  810674  810675	810673	10A 1 way Switch	1	54	1/20/200		
	810674	10A 2 way Switch	1	108	1/20/200		
	810675	10A 1 way Switch with Indicator	1	106	1/20/200		



### Switches 16A 230 V AC

**HSN Code: 8536**

			Cat. Nos.	Description	Module	MRP ₹ / Unit	Pack
 810601  810611	810601	16A 1 way Switch	1	126	1/20/200		
	810611	16A 2 way Switch	1	172	1/10/100		
	810603	16A 1 way Switch with Indicator	1	154	1/20/200		

### Switches 20A 230V AC

**HSN Code: 8536**

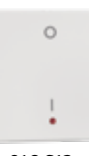
			Cat. Nos.	Description	Module	MRP ₹ / Unit	Pack
 810606  810607  810612	810606	20A 1 way Switch	1	170	1/20/200		
	810607	20A 1 way Switch with Indicator	1	196	1/20/200		
	810609	20A SP 1 way Switch	2	244	1/10/100		
	810612	20A DP switch with Indicator	2	220	1/10/100		

### Switches 25A 230 V AC

**HSN Code: 8536**

			Cat. Nos.	Description	Module	MRP ₹ / Unit	Pack
 810608	810608	25A 1 way Switch with Indicator	1	230	1/20/200		

### Switches 32A 230 V AC

**HSN Code: 8536**

			Cat. Nos.	Description	Module	MRP ₹ / Unit	Pack
 810613	810613	32A DP switch with indicator	2	304	1/10/100		

# Shynora

## Bell Push Button 6A 230 V AC

**HSN Code: 8536**

Cat. Nos.	Description	Module	MRP ₹ / Unit	Pack
810615	6A Bell Push Switch	1	108	1/20/200
810616	6A Bell Push Switch with Indicator	1	112	1/20/200
810617	6A Bell Push Switch with Indicator	2	174	1/10/100

## Accessories for Switches

**HSN Code: 8536**

Cat. Nos.	Description	Module	MRP ₹ / Unit	Pack
810650	LED Indicator for switch	-	44	1/5/25

## Indian Standard Sockets 240 V AC

**HSN Code: 8536**
**Sockets:** • Child Safety Shutter • Shrouded Terminals • Smooth Plug Removal & Insertion

Cat. Nos.	Description	Module	MRP ₹ / Unit	Pack
810620	6A 3 pin Round Socket with shutter (ISI mark)	2	132	1/20/200
810621	6A/16A 3 pin socket with shutter (ISI Mark)	2	250	1/10/100

## Dimmers and Fan Regulators • Laser Marking

**HSN Code: 8538 & 8414**

Cat. Nos.	Description	Module	MRP ₹ / Unit	Pack
810641	Light Dimmer - 400W	1	482	1/10/100
810642	Light Dimmer - 500W	2	620	1/10/100
810638	Fan 4 Step Regulator 100W (ISI mark)	1	458	1/10/100
810639	Fan Step Regulator 360 deg 100W (ISI mark)	2	594	1/10/100
810640	Fan 8 step Regulator 100W (ISI mark)	2	696	1/10/100

## Skirting Light

**HSN Code: 9405**

Cat. Nos.	Description	Module	MRP ₹ / Unit	Pack
810649	Skirting Light	2	464	1/5/50

## Indicator

**HSN Code: 8536**

Cat. Nos.	Description	Module	MRP ₹ / Unit	Pack
810645	Flat Indicator Red	1	140	1/20/200

# Shynora

## Bell Call Indicator

HSN Code: 8536

	Cat. Nos.	Description	Module	MRP ₹ / Unit	Pack
 810644	810644	Bell Call Indicator	1	794	1/20/100

## Buzzer



HSN Code: 8536

	Cat. Nos.	Description	Module	MRP ₹ / Unit	Pack
 810637	810637	Buzzer - 230V	1	338	1/20/100

## Hospitality Function



### Hotel Keycard Switch

HSN Code: 8538

	Cat. Nos.	Description	Module	MRP ₹ / Unit	Pack
 810614	810614	32A DP Keytag Switch (Mechanical)	2	542	1/10
 810646	810678	Keytag for (810614)		258	1/10/100
	810646	Key Card SW 15A + KEY FOB	2	2,790	1/10

### Hotel "DND and MMR" Functions

HSN Code: 8538

	Cat. Nos.	Description	Module	MRP ₹ / Unit	Pack
 810647	810647	DND Internal Unit	2	364	1/10/100
 810648	810648	DND External Unit	2	432	1/10/100

## Shaver Socket

HSN Code: 8538

	Cat. Nos.	Description	Module	MRP ₹ / Unit	Pack
 810666	810666	Shaver Socket	4	4918	1/5/20

## Sockets and Connectors



### TV Socket

HSN Code: 8536

	Cat. Nos.	Description	Module	MRP ₹ / Unit	Pack
 810633	810633	TV Socket	1	126	1/20/200

### Data & Voice

HSN Code: 8536

	Cat. Nos.	Description	Module	MRP ₹ / Unit	Pack
 810631	810631	Telephone Socket - RJ11 with shutter	1	124	1/20/200
 810632	810632	Computer Socket - RJ45 Cat 6 with shutter	1	706	1/20/200

# Shynora

## Sound (Electronic Bell)

HSN Code: 8536



810643

Cat. Nos.	Description	Module	MRP ₹ / Unit	Pack
810643	Electronic Bell	2	376	1/10/100

## Protectors and Accessories

### Motor Starter

HSN Code: 8536



810664



810665

Cat. Nos.	Description	Module	MRP ₹ / Unit	Pack
810664	16A MOTOR STARTER	2	644	10/50
810665	25A MOTOR STARTER	2	644	10/50

### Modular MCB (IS : 608981:2002) • ISI Mark

HSN Code: 8536



810654



810655



810657



810660

Cat. Nos.	Description	Module	MRP ₹ / Unit	Pack
810654	6A MINI MCB SP C CURVE	1	488	1/1/100
810655	10A MINI MCB SP C CURVE	1	488	1/1/100
810656	16A MINI MCB SP C CURVE	1	488	1/1/100
810657	20A MINI MCB SP C CURVE	1	488	1/1/100
810658	25A MINI MCB SP C CURVE	1	488	1/1/100
810659	32A MINI MCB SP C CURVE	1	488	1/1/100
810660	16A MINI MCB DP C CURVE	2	866	1/1/100
810661	20A MINI MCB DP C CURVE	2	866	1/1/100
810662	25A MINI MCB DP C CURVE	2	866	1/1/100
810663	32A MINI MCB DP C CURVE	2	866	1/1/100

### Power Unit

HSN Code: 8536



810625



810626

Cat. Nos.	Description	Module	MRP ₹ / Unit	Pack
810625	Power Unit Wth 20A MCB & 16A Plug	3	1,162	1/10
810626	Power Unit Wth 25A MCB & 16A Plug	3	1,246	1/10

## Effortless charging, simplified living



Scan to know more  
about the product

**Shynora** USB Chargers deliver fast, safe charging with new Type C PD (20W) along with Type A+C options with CRS certified and RoHS compliant.

### Features

- Type C PD 20W fast charging along with Type A+C(15W) charging option
- CRS certified with RoHS compliance
- Dual port option Type A+C(15W) and Type A+A(15W) USB charging option

### Benefits



- Reduces cable clutter with versatile Type A/C/A+C port options
- Ensures fast charging to maintain continuous operation
- Matches Shynora aesthetics in white/cool grey mechanisms

# Shynora

## Electronic Function



### USB Chargers (IS13252 (Part 1) / IEC 60950-1) • CRS Certified

HSN Code: 8536

			Cat. Nos.	Description	Module	MRP ₹ / Unit	Pack
 810652  810651  810669	810652	USB Charger 1500mA Type A	1	1,084	1/10/100		
	810651	Double USB charger 3000mA Type A+A	2	1,736	1/10/100		
	810676	USB Charger Type C 20W PD	1	2,940	1/10/100		
	810677	USB Charger 3000mA, 15W Type A+C	1	2,214	1/10/100		
	810669	Double USB Charger 3000mA, 15W Type A+C	2	1,972	1/10/100		

## Accessories

HSN Code: 8538



			Cat. Nos.	Description	Module	MRP ₹ / Unit	Pack
 810667  810668	810667	1 Module Blank Plate	1	32	1/40/400		
	810668	Cable Outlet	1	100	1/20/100		

## Cool Grey Mechanisms

**Switches:** • Polycarbonate Material • LED Based Indicator • Shrouded Terminal • ISI Marked



### Switches 6A 230 V AC

HSN Code: 8536

			Cat. Nos.	Description	Module	MRP ₹ / Unit	Pack
 810700  810710  810704	810700	6A 1 way Switch	1	56	1/20/400		
	810710	6A 2 way Switch	1	116	1/20/200		
	810702	6A 1 way Switch with Indicator	1	110	1/20/200		
	810704	6A 1 way Switch with "Light" Marking	1	122	1/20/200		
	810705	6A 1 way Switch with "Fan" Marking	1	122	1/20/200		



### Switches 16A 230 V AC

HSN Code: 8536

			Cat. Nos.	Description	Module	MRP ₹ / Unit	Pack
 810701  810703	810701	16A 1 way Switch	1	154	1/20/200		
	810711	16A 2 way Switch	1	208	1/10/100		
	810703	16A 1 way Switch with Indicator	1	166	1/20/200		

### Switches 20A 230V AC

HSN Code: 8536

			Cat. Nos.	Description	Module	MRP ₹ / Unit	Pack
 810706  810707  810712	810706	20A 1 way Switch	1	198	1/20/200		
	810707	20A 1 way Switch with Indicator	1	228	1/20/200		
	810709	20A SP 1 way Switch	2	280	1/10/100		
	810712	20A DP switch with Indicator	2	252	1/10/100		

# Shynora

## Switches 25A 230 V AC

HSN Code: 8536

	Cat. Nos.	Description	Module	MRP ₹ / Unit	Pack
 810708	810708	25A 1 way Switch with Indicator	1	250	1/20/200



## Switches 32A 230 V AC

HSN Code: 8536

	Cat. Nos.	Description	Module	MRP ₹ / Unit	Pack
 810713	810713	32A DP switch with indicator	2	350	1/10/100

## Bell Push Button 6A 230 V AC

HSN Code: 8536

	Cat. Nos.	Description	Module	MRP ₹ / Unit	Pack
	810715	6A Bell Push Switch	1	126	1/20/200
	810716	6A Bell Push Switch with Indicator	1	138	1/20/200
	810717	6A Bell Push Switch with Indicator	2	202	1/10/100

## Indian Standard Sockets 240 V AC



HSN Code: 8536

**Sockets:** • Child Safety Shutter • Shrouded Terminals • Smooth Plug Removal & Insertion

	Cat. Nos.	Description	Module	MRP ₹ / Unit	Pack
 810720	810720	6A 3 pin Round Socket with shutter (ISI mark)	2	156	1/20/200
 810721	810721	6A/16A 3 pin socket with shutter (ISI Mark)	2	288	1/10/100

## Dimmers & Fan Regulators • Laser Marking

HSN Code: 8538 & 8414

	Cat. Nos.	Description	Module	MRP ₹ / Unit	Pack
	810741	Light Dimmer - 400W	1	552	1/10/100
	810742	Light Dimmer - 500W	2	726	1/10/100
	810738	Fan Step Regulator 100W (ISI mark)	1	528	1/10/100
	810739	Fan Step Regulator 360 deg 100W (ISI mark)	2	696	1/10/100
	810740	Fan 8 step Regulator 100W (ISI mark)	2	840	1/10/100

## Skirting Light

HSN Code: 9405

	Cat. Nos.	Description	Module	MRP ₹ / Unit	Pack
 810749	810749	Skirting Light	2	506	1/5/50

# Shynora

## Indicator

HSN Code: 8536



810745

Cat. Nos.	Description	Module	MRP ₹ / Unit	Pack
810745	Flat Indicator Red	1	150	1/20/200

## Buzzer

HSN Code: 8536



810737

Cat. Nos.	Description	Module	MRP ₹ / Unit	Pack
810737	Buzzer - 230V	1	390	1/20/100

## Hospitality Function

### Hotel Keycard Switch

HSN Code: 8538



810714



810746

Cat. Nos.	Description	Module	MRP ₹ / Unit	Pack
810714	32A DP Keytag Switch (Mechanical)	2	624	1/10
810778	Keytag for (810714)		298	1/10/100
810746	Key Card SW 15A + KEY FOB	2	3,568	1/10

### Hotel "DND and MMR" Functions

HSN Code: 8538



810747



810748

Cat. Nos.	Description	Module	MRP ₹ / Unit	Pack
810747	DND Internal Unit	2	448	1/10/100
810748	DND External Unit	2	508	1/10/100

## Shaver Socket

HSN Code: 8538



810766

Cat. Nos.	Description	Module	MRP ₹ / Unit	Pack
810766	Shaver Socket	4	6,094	1/5/20

## Sockets and Connectors

### TV Socket

HSN Code: 8536



810733

Cat. Nos.	Description	Module	MRP ₹ / Unit	Pack
810733	TV Socket	1	146	1/20/200

# Shynora

## Data & Voice

HSN Code: 8536



810731

Cat. Nos.	Description	Module	MRP ₹ / Unit	Pack
810731	Telephone Socket - RJ11 with shutter	1	144	1/20/200
810732	Computer Socket - RJ45 Cat 6 with shutter	1	820	1/20/200

## Protectors and Accessories

### Motor Starter

HSN Code: 8536



810764



810765

Cat. Nos.	Description	Module	MRP ₹ / Unit	Pack
810764	16A Motor Starter	2	758	10/50
810765	25A Motor Starter	2	758	10/50

### Modular MCB (IS : 608981:2002) • ISI Mark

HSN Code: 8536



810754



810757



810758

Cat. Nos.	Description	Module	MRP ₹ / Unit	Pack
810754	6A Mini MCB SP C Curve	1	564	1/1/100
810755	10A Mini MCB SP C Curve	1	564	1/1/100
810756	16A Mini MCB SP C Curve	1	564	1/1/100
810757	20A Mini MCB SP C Curve	1	564	1/1/100
810758	25A Mini MCB SP C Curve	1	564	1/1/100
810759	32A Mini MCB SP C Curve	1	564	1/1/100

### Power Unit

HSN Code: 8536



810725

Cat. Nos.	Description	Module	MRP ₹ / Unit	Pack
810725	Power Unit with 20A MCB & 16A Plug	3	1,354	1/10
810726	Power Unit with 25A MCB & 16A Plug	3	1,454	1/10

## Electronic Function

### USB Chargers (IS13252 (Part 1) / IEC 60950-1) • CRS Certified

HSN Code:8536



810752



810751



810769

Cat. Nos.	Description	Module	MRP ₹ / Unit	Pack
810752	USB Charger 1500mA Type A	1	1,354	1/10/100
810751	Double USB charger 3000mA Type A+A	2	2,004	1/10/100
810776	USB Charger Type C 20W PD	1	3,318	1/10/100
810777	USB Charger 3000mA, 15W Type A+C	1	2,398	1/10/100
810769	Double USB Charger 3000mA, 15W Type A+C	2	2,246	1/10/100

# Shynora

## Accessories

HSN Code: 8538

Cat. Nos.	Description	Module	MRP ₹ / Unit	Pack
810767	1 Module Blank Plate	1	38	1/40/400
810768	Cable Outlet	1	108	1/20/100



## Shynora Plate Frame White

HSN Code: 8538

### Plate & Frame • Strong Dimensional Stability

Cat. Nos.	Description	Module	MRP ₹ / Unit	Pack
810800	White Plate + Frame, 1 module	1	102	1/10/100
810801	White Plate + Frame, 2 module	2	102	1/10/100
810802	White Plate + Frame, 3 module	3	152	1/10/100
810803	White Plate + Frame, 4 module	4	162	1/10/100
810804	White Plate + Frame, 6 module	6	224	1/10/100
810805	White Plate + Frame, 8 module	8	288	1/10/100
810806	White Plate + Frame, 2X4 module	8	288	1/5/25
810807	White Plate + Frame, 9 module	9	322	1/5/50
810808	White Plate + Frame, 12 module	12	380	1/5/25
810809	White Plate + Frame, 16 module	16	434	1/5/25
810810	White Plate + Frame, 18 module	18	508	1/5/25



810800



810801



810805



810810

## Shynora Plate Frame Cool Grey

HSN Code: 8538

Cat. Nos.	Description	Module	MRP ₹ / Unit	Pack
810811	Cool Grey Plate + Frame, 1 module	1	126	1/10/100
810812	Cool Grey Plate + Frame, 2 module	2	126	1/10/100
810813	Cool Grey Plate + Frame, 3 module	3	184	1/10/100
810814	Cool Grey Plate + Frame, 4 module	4	198	1/10/100
810815	Cool Grey Plate + Frame, 6 module	6	278	1/10/100
810816	Cool Grey Plate + Frame, 8 module	8	320	1/10/100
810817	Cool Grey Plate + Frame, 2X4 module	8	320	1/5/25
810818	Cool Grey Plate + Frame, 9 module	9	394	1/5/50
810819	Cool Grey Plate + Frame, 12 module	12	462	1/5/25
810820	Cool Grey Plate + Frame, 16 module	16	520	1/5/25
810821	Cool Grey Plate + Frame, 18 module	18	626	1/5/25



810811



810812



810814



810816

## Shynora Plate Frame Chrome

HSN Code: 8538

Cat. Nos.	Description	Module	MRP ₹ / Unit	Pack
810833	Chrome Plate + Frame, 1 module	1	114	1/10/100
810834	Chrome Plate + Frame, 2 module	2	114	1/10/100



810833

# Shynora

## Shynora Plate Frame Chrome

**HSN Code: 8538**

	Cat. Nos.	Description	Module	MRP ₹ / Unit	Pack
	810835	Chrome Plate + Frame, 3 module	3	160	1/10/100
	810836	Chrome Plate + Frame, 4 module	4	186	1/10/100
	810837	Chrome Plate + Frame, 6 module	6	260	1/10/100
	810838	Chrome Plate + Frame, 8 module	8	302	1/10/100
	810839	Chrome Plate + Frame, 2X4 module	8	302	1/5/25
	810840	Chrome Plate + Frame, 9 module	9	374	1/5/50
	810841	Chrome Plate + Frame, 12 module	12	428	1/5/25
	810842	Chrome Plate + Frame, 16 module	16	494	1/5/25
	810843	Chrome Plate + Frame, 18 module	18	590	1/5/25

## Shynora Plate Frame Pink

**HSN Code: 8538**

	Cat. Nos.	Description	Module	MRP ₹ / Unit	Pack
	810844	Pink Plate + Frame, 1 module	1	140	1/10/100
	810845	Pink Plate + Frame, 2 module	2	140	1/10/100
	810846	Pink Plate + Frame, 3 module	3	192	1/10/100
	810847	Pink Plate + Frame, 4 module	4	222	1/10/100
	810848	Pink Plate + Frame, 6 module	6	316	1/10/100
	810849	Pink Plate + Frame, 8 module	8	388	1/10/100
	810850	Pink Plate + Frame, 2X4 module	8	388	1/5/25
	810851	Pink Plate + Frame, 9 module	9	456	1/5/50
	810852	Pink Plate + Frame, 12 module	12	522	1/5/25
	810853	Pink Plate + Frame, 16 module	16	654	1/5/25
810854	Pink Plate + Frame, 18 module	18	712	1/5/25	

## Shynora Plate Frame Milan Gold

**HSN Code: 8538**





	Cat. Nos.	Description	Module	MRP ₹ / Unit	Pack
	810855	Milan Gold Plate + Frame, 1 module	1	140	1/10/100
	810856	Milan Gold Plate + Frame, 2 module	2	140	1/10/100
	810857	Milan Gold Plate + Frame, 3 module	3	192	1/10/100
	810858	Milan Gold Plate + Frame, 4 module	4	222	1/10/100
	810859	Milan Gold Plate + Frame, 6 module	6	316	1/10/100
	810860	Milan Gold Plate + Frame, 8 module	8	388	1/10/100
	810861	Milan Gold Plate + Frame, 2X4 module	8	388	1/5/25
	810862	Milan Gold Plate + Frame, 9 module	9	456	1/5/50
	810863	Milan Gold Plate + Frame, 12 module	12	522	1/5/25
	810864	Milan Gold Plate + Frame, 16 module	16	654	1/5/25
810865	Milan Gold Plate + Frame, 18 module	18	712	1/5/25	

# Shynora





**Metal Flush Boxes • Made of G.I. Sheet • Earth Terminal for Safety • Provision for Knockouts Available**

• ISI Marked

**HSN Code: 8538**

	Cat. Nos.	Description	Module	MRP ₹ / Unit	Pack
 800172	800172	Metal Flush Box, 1/2 Module	1/2	78	40
 800174	800173	Metal Flush Box, 3 Module	3	102	40
 810867	800174	Metal Flush Box, 4 Module	4	120	40
 800180	800176	Metal Flush Box, 6 Module	6	180	20
	800177	Metal Flush Box, 8 Module (vertical)	8	232	20
	800178	Metal Flush Box, 8 Module (horizontal)	8	232	20
	810867	Metal Flush Box, 9 Module	9	278	20
	800175	Metal Flush Box, 12 Module	12	304	10
	800179	Metal Flush Box, 16 Module	16	350	10
	800180	Metal Flush Box, 18 Module	18	382	10

**Plastic Surface Boxes • Flame Retardant Material • Edge to Edge Fitting with Plate • ISI Marked HSN Code: 8538**

	Cat. Nos.	Description	Module	MRP ₹ / Unit	Pack
 800182	800182	Plastic Surface Box, 1/2 Module	1/2	80	50
 800184	800183	Plastic Surface Box, 3 Module	3	102	35
	800184	Plastic Surface Box, 4 Module	4	116	25
	800186	Plastic Surface Box, 6 Module	6	176	10
 800187	800187	Plastic Surface Box, 8 Module (vertical)	8	240	15
 800185	810866	Plastic Surface Box, 8 Module (horizontal)	8	252	10
	800185	Plastic Surface Box, 12 Module	12	302	10
	800189	Plastic Surface Box, 16 Module	16	352	10
	800190	Metal Surface Box, 18 Module	18	392	10

## Dimensions

### Cover Plates-Shynora

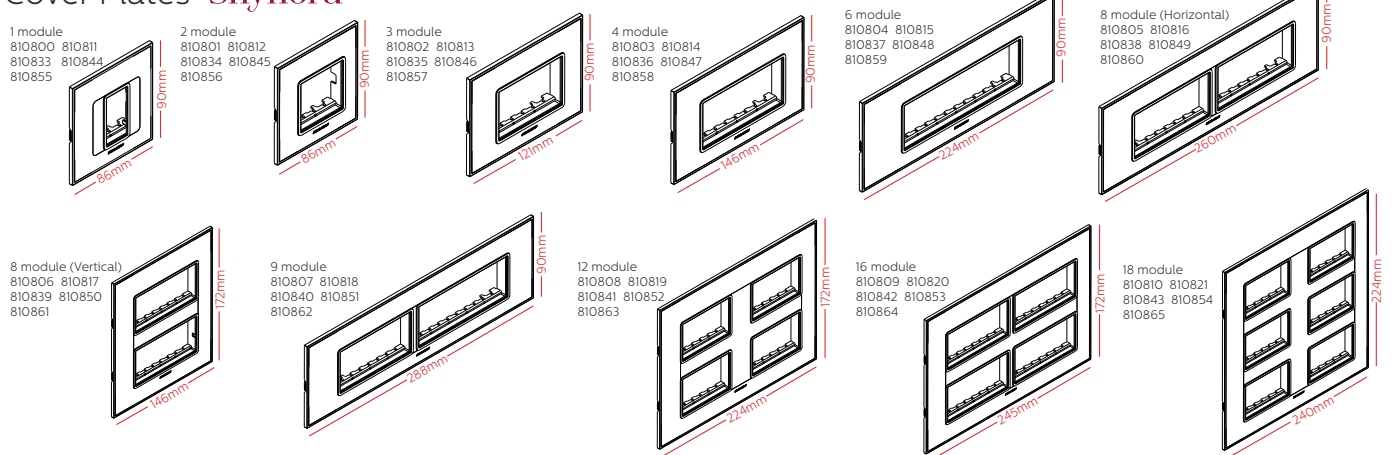

### Flush Boxes-Metal

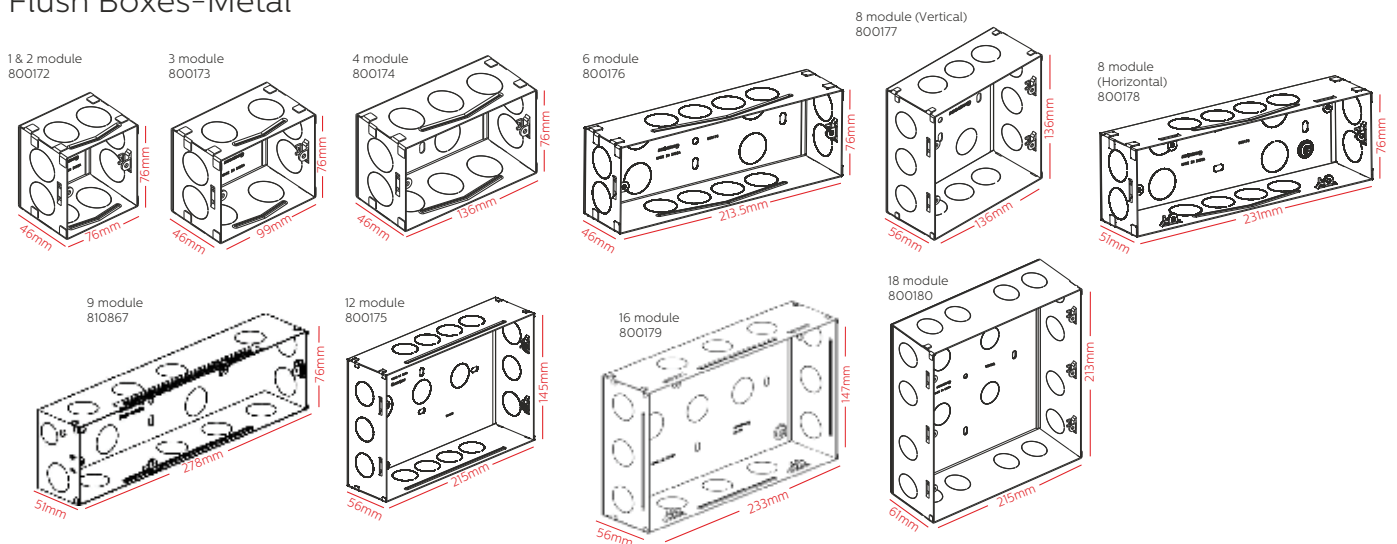

### Surface Boxes-Plastic

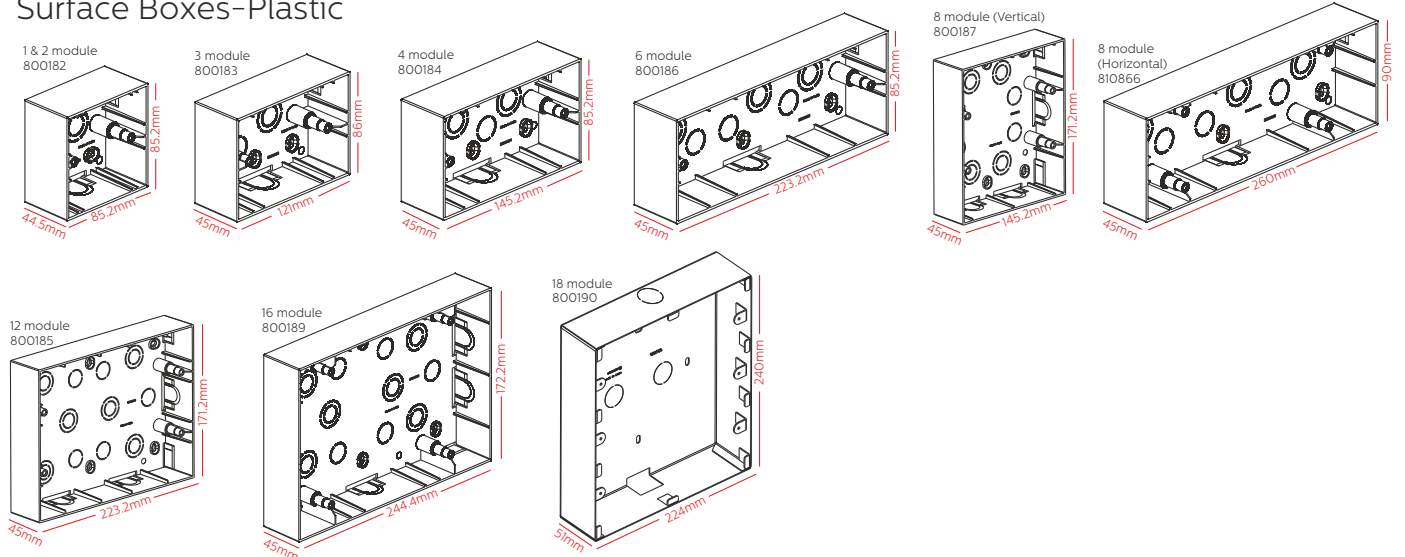

## Elevate your space with refined elegance



Scan to know more about the product

**Glint** is a wiring device range designed to suit everyday interiors suitable for residential and commercial applications.

### Features

- Switches tested for up to 1 lakh on/off operations along with safety shuttered sockets
- Modular design for quick assembly with heat resistant body for enhanced safety
- ISI and RoHS Certified

### Benefits

- An economical modular system built for diverse applications
- Easy installation & low maintenance
- Ensures safe operation and long product life



# Glint™

## Mechanisms White

**Switches:** • Polycarbonate Material • LED Based Indicator • ISI Marked



### Switches 6A 230 V AC

**HSN Code: 8536**

 		Cat. Nos.	Description	Module	MRP ₹ / Unit	Pack
800000	800001	800000	6A 1 way Switch	1	38	1/20/400
		800001	6A 2 way Switch	1	80	1/20/200

### Switches 16A 230 V AC

**HSN Code: 8536**

  			Cat. Nos.	Description	Module	MRP ₹ / Unit	Pack
800002	800003	800004	800002	16A 1 way Switch	1	108	1/20/200
			800003	16A 2 way Switch	1	138	1/10/100
			800004	16A 1 way Switch with indicator	1	132	1/10/100

### Switches 20A 230V AC

**HSN Code: 8536**

		Cat. Nos.	Description	Module	MRP ₹ / Unit	Pack
800005		800005	20A DP Switch with indicator	2	166	1/10/50

### Switches 25A 230V AC

**HSN Code: 8536**

		Cat. Nos.	Description	Module	MRP ₹ / Unit	Pack
800089		800089	25A Switch with Indicator	1	142	1/10/100



### Switches 32A 230 V AC

**HSN Code: 8536**

		Cat. Nos.	Description	Module	MRP ₹ / Unit	Pack
800006		800006	32A DP Switch with indicator	2	240	1/10/50

### Bell Push Button 6A 230 V AC

**HSN Code: 8536**

 		Cat. Nos.	Description	Module	MRP ₹ / Unit	Pack
800007	800008	800007	6A Bell Push with Indicator	1	94	1/10/100
		800008	6A Bell Push with Indicator	2	140	1/10/100

# Glint™

## Mechanisms White

**Sockets:** • Child Safety Shutter • Smooth Plug Removal & Insertion

### Indian Standard Sockets 240 V AC

HSN Code: 8536

	Cat. Nos.	Description	Module	MRP ₹ / Unit	Pack
 800022	801800	6A 3 pin Round Socket with shutter ( ISI mark)	2	80	1/20/200
	800022	6A/16A 3 pin socket with shutter ( ISI Mark)	2	152	1/10/100

### Dimmers and Fan Regulators •Laser Marking for Easy Identification

HSN Code: 8538 & 8414

	Cat. Nos.	Description	Module	MRP ₹ / Unit	Pack
 800042      800043	800042	Light Dimmer -400W	1	390	1/10/100
	800041	Fan 4 Step Regulator -100W	1	400	1/10/100
	800043	Fan 4 Step Regulator -100W	2	450	1/10/100
	800090	Fan 5 Step Regulator -100W ( ISI mark)	2	398	1/10/100
	800091	Fan 8 Step Regulator -100W ( ISI mark)	2	398	1/10/100

### Skirting Light

HSN Code: 8536

	Cat. Nos.	Description	Module	MRP ₹ / Unit	Pack
 800092	800092	Skirting Light	2	296	1/5/25

### Indicator

HSN Code: 8536

	Cat. Nos.	Description	Module	MRP ₹ / Unit	Pack
 800033	800033	Flat Indicator Red	1	116	1/10/100

### Buzzer

HSN Code: 8536

	Cat. Nos.	Description	Module	MRP ₹ / Unit	Pack
 800040	800040	Buzzer - 230V	1	224	1/20/100

### Hospitality Function

#### Hotel Keycard Switch

HSN Code: 8536

	Cat. Nos.	Description	Module	MRP ₹ / Unit	Pack
 800093	800093	32A DP Keytag Switch (Mechanical)	2	392	1/10

# Glint™

## Hotel “DND and MMR” Functions

HSN Code: 8536

	Cat. Nos.	Description	Module	MRP ₹ / Unit	Pack
 800094	800094	DND Internal Unit	2	144	1/10/100
	800095	DND External Unit	2	260	1/10/100

## Sockets and Connectors

### TV Socket

HSN Code: 8536

	Cat. Nos.	Description	Module	MRP ₹ / Unit	Pack
 800032	800032	TV Socket	1	80	1/20/100

### Data & Voice

HSN Code: 8536

	Cat. Nos.	Description	Module	MRP ₹ / Unit	Pack
 800030	800030	Telephone Socket - RJ11	1	88	1/20/100
	800031	Computer Socket- RJ45 Cat 6	1	200	1/20/100

## Protectors and Accessories

### Modular MCB (IS : 608981:2002) • Laser Marking

HSN Code: 8536

	Cat. Nos.	Description	Module	MRP ₹ / Unit	Pack
 800097	800097	6A MINI MCB SP C CURVE	1	252	1/10/100
	800098	10A MINI MCB SP C CURVE	1	252	1/10/100
	800010	16A MINI MCB SP C CURVE	1	380	1/10/100
	800011	20A MINI MCB SP C CURVE	1	380	1/10/100
	800012	25A MINI MCB SP C CURVE	1	380	1/10/100
	800013	32A MINI MCB SP C CURVE	1	380	1/10/100

### Motor Starter

HSN Code: 8536

	Cat. Nos.	Description	Module	MRP ₹ / Unit	Pack
 800096	800096	25A MOTOR STARTER	2	414	1/10/50

## Electronic Function

### USB Chargers (IS13252 (Part 1) / IEC 60950-1) • CRS Certified

HSN Code: 8536

	Cat. Nos.	Description	Module	MRP ₹ / Unit	Pack
 800044	800044	USB Charger 1500mA Type A	1	942	1/10/100

# Glint™

## Accessories • Spare Screw Caps

HSN Code: 8538

Cat. Nos.	Description	Module	MRP ₹ / Unit	Pack
800051	1 Module Blank Plate	1	28	1/20/200
800052	2 Module Blank Plate	2	32	1/10/100
800059	Screw Caps	0	28	1/10/100

**Plate & Frame:** • Unique Design - Sleek & Curvy • Flame Retardant Material • Compatible with Standard Size of Metal Flush & Plastic Surface Boxes

## Glint Single Plates White

HSN Code: 8538

Cat. Nos.	Description	Module	MRP ₹ / Unit	Pack
800061	1 Module Plate	1	62	1/10/100
800062	2 Module Plate	2	62	1/10/100
800063	3 Module Plate	3	88	1/10/100
800064	4 Module Plate	4	104	1/10/100
800066	6 Module Plate	6	130	1/5/50
800067	8 Module Plate (Vertical)	8	182	1/5/25
800068	8 Module Plate (Horizontal)	8	172	1/5/50
800065	12 Module Plate	12	238	1/5/25
800069	16 Module Plate	16	248	1/5/25
800070	18 Module Plate	18	302	1/5/25

**Glint Double Plates:** • Aesthetic Design • Suitable for Metal Flush & Wooden Boxes • Comes with Regular & Self Tapping Screws

## Plate & Frame

HSN Code: 8538

Cat. Nos.	Description	Module	MRP ₹ / Unit	Pack
800071	White Plate + Frame, 1M	1	92	1/10/100
800072	White Plate + Frame, 2M	2	92	1/10/100
800073	White Plate + Frame, 3M	3	118	1/10/100
800074	White Plate + Frame, 4M	4	150	1/10/100
800076	White Plate + Frame, 6M	6	188	1/10/50
800078	White Plate + Frame, 8M (Vertical)	8	268	1/5/25
800079	White Plate + Frame, 8M (Horizontal)	8	268	1/10/50
800080	White Plate + Frame, 10M	10	318	1/5/25
800082	White Plate + Frame, 12M (Vertical)	12	346	1/5/25
800084	White Plate + Frame, 12M (Horizontal)	12	346	1/5/25
800086	White Plate + Frame, 16M	16	392	1/5/25
800088	White Plate + Frame, 18M	18	426	1/5/25

# Glint™

## Metal Flush Boxes

HSN Code: 8538



800172

800174

Cat. Nos.	Description	Module	MRP ₹ / Unit	Pack
800172	Metal Flush Box, 1/2 Module	1/2	78	40
800173	Metal Flush Box, 3 Module	3	102	40
800174	Metal Flush Box, 4 Module	4	120	40
800176	Metal Flush Box, 6 Module	6	180	20
800177	Metal Flush Box, 8 Module (vertical)	8	232	20
800178	Metal Flush Box, 8 Module (horizontal)	8	232	20
810867	Metal Flush Box, 9 Module	9	278	20
800175	Metal Flush Box, 12 Module	12	304	10
800179	Metal Flush Box, 16 Module	16	350	10
800180	Metal Flush Box, 18 Module	18	382	10

## Plastic Surface Boxes

HSN Code: 8538



800182

800188

Cat. Nos.	Description	Module	MRP ₹ / Unit	Pack
800182	Plastic Surface Box, 1/2 Module	1/2	80	50
800183	Plastic Surface Box, 3 Module	3	102	35
800184	Plastic Surface Box, 4 Module	4	116	25
800186	Plastic Surface Box, 6 Module	6	176	10
800187	Plastic Surface Box, 8 Module (vertical)	8	240	15
800188	Plastic Surface Box 8 Module (horizontal)	8	240	10
800185	Plastic Surface Box, 12 Module	12	302	10
800189	Plastic Surface Box, 16 Module	16	352	10
800190	Metal Surface Box, 18 Module	18	392	10

## Dimensions

### Cover Plates-Glint™

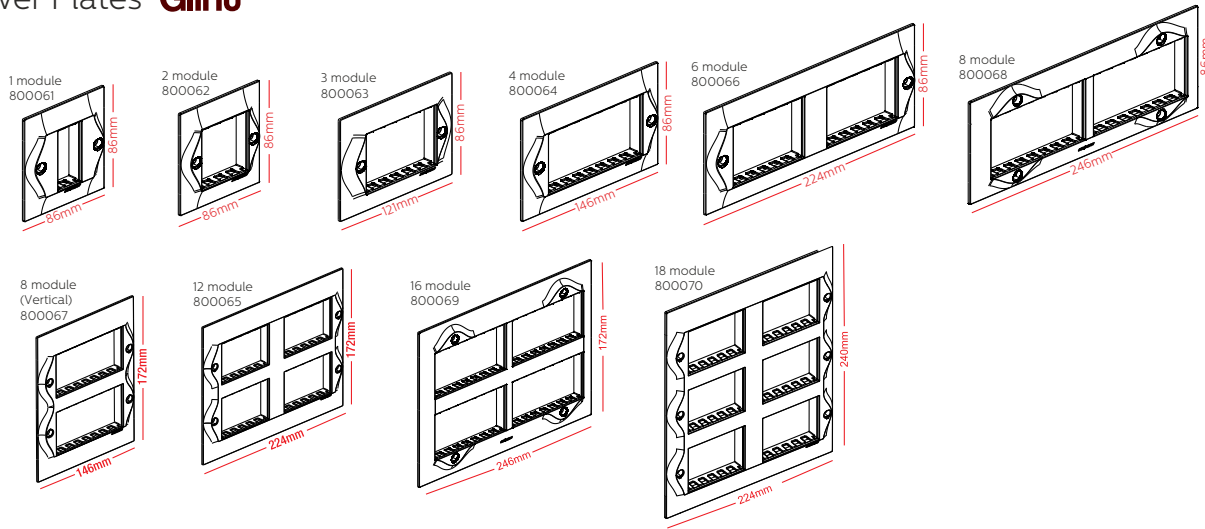

### Flush Boxes-Metal

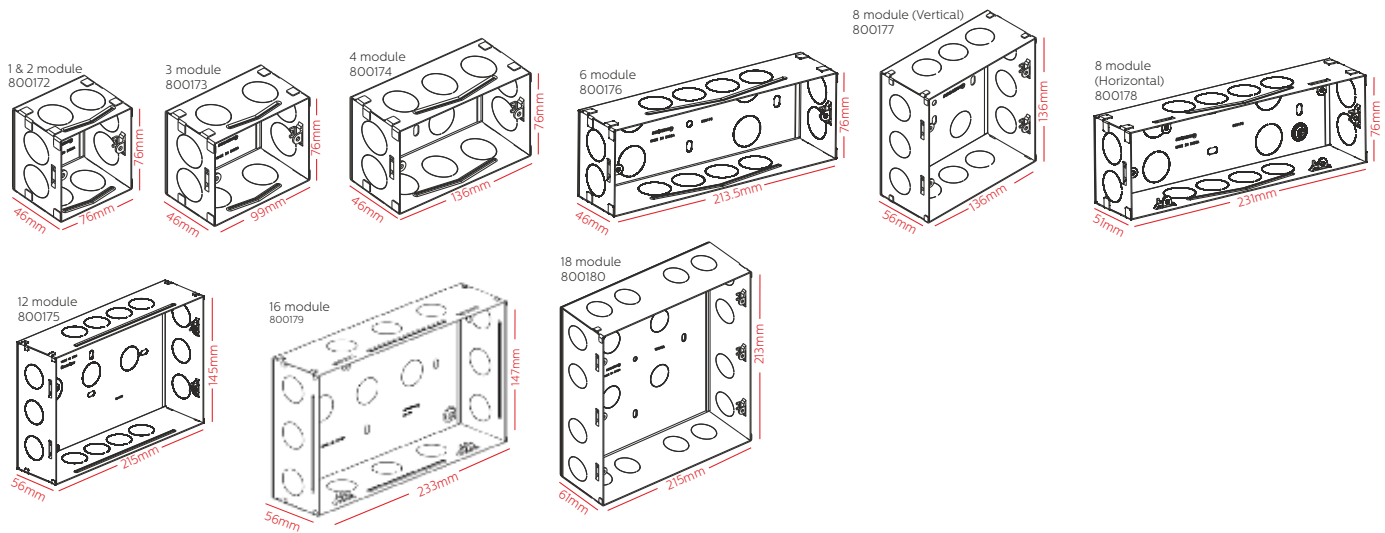

### Surface Boxes-Plastic

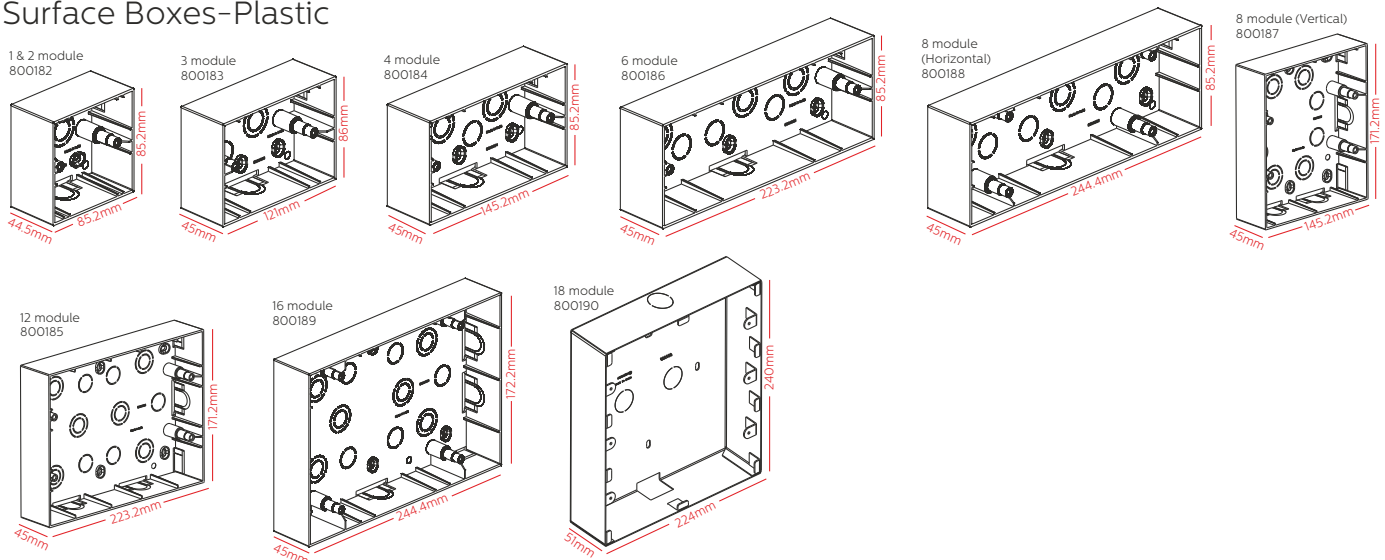

**We think better,  
you live better**



Scan to know more  
about the product

**Elvira** is a modular range designed for modern residential and commercial spaces. It combines sleek design and durable performance, with ISI certified products.

## Features

- Switches tested for up to 1 lakh on/off operations along with safety shuttered sockets
- Simple design enabling quick & easy installation
- Flame retardant plastic material used for end user safety
- ISI certified switches and sockets compliant with RoHS & BIS standards

## Benefits

- Designed for long-term reliability with safety
- Balances modern aesthetics with safe operation
- Tested for electrical, mechanical, and thermal strength



# ELVIRA

## White Mechanisms

Switches: • Polycarbonate Material • LED Based Indicator • ISI Marked



### Switches 6A 230 V AC

HSN Code: 8536

		Cat. Nos.	Description	Module	MRP ₹ / Unit	Pack
 800100	 800101	800100	6A 1 way Switch	1	42	1/20/400
		800101	6A 2 way Switch	1	98	1/20/100
		800102	6A 1 way Switch with Indicator	1	96	1/20/200



### Switches 10A 230 V AC

HSN Code: 8536

		Cat. Nos.	Description	Module	MRP ₹ / Unit	Pack	
 800114	 800115	 800116	800114	10A 1 way Switch	1	46	1/20/400
			800115	10A 2 way Switch	1	102	1/20/100
			800116	10A 1 way Switch with Indicator	1	100	1/20/200

### Switches 16A 230 V AC

HSN Code: 8536

		Cat. Nos.	Description	Module	MRP ₹ / Unit	Pack	
 800103	 800104	 800105	800103	16A 1 way Switch	1	124	1/20/200
			800104	16A 2 way Switch	1	168	1/10/100
			800105	16A 1 way Switch with Indicator	1	146	1/20/200

### Switches 20A 230V AC

HSN Code: 8536

		Cat. Nos.	Description	Module	MRP ₹ / Unit	Pack
 800107	800107		20A DP Switch with indicator	2	214	1/10/50

### Switches 25A 230 V AC

HSN Code: 8536

		Cat. Nos.	Description	Module	MRP ₹ / Unit	Pack
 800106	800106		25A 1 way Switch with Indicator	1	222	1/10/100

### Switches 32A 230 V AC

HSN Code: 8536

		Cat. Nos.	Description	Module	MRP ₹ / Unit	Pack
 800108	800108		32A DP Switch with indicator	2	296	1/10/50

# ELVIRA

## Bell Push Button 6A 230 V AC

HSN Code: 8536

Cat. Nos.	Description	Module	MRP ₹ / Unit	Pack
800110	6A Bell Push with Indicator	1	110	1/20/200
800111	6A Bell Push with Indicator	2	172	1/10/100



## Indian Standard Sockets 240 V AC:

HSN Code: 8536

Sockets • Child Safety Shutter • Smooth Plug Removal & Insertion

Cat. Nos.	Description	Module	MRP ₹ / Unit	Pack
802800	6A 3 pin Round Socket with Shutter (ISI Mark)	2	104	1/20/200
800122	6A/16A 3 Pin Socket with Shutter (ISI Mark)	2	206	1/10/50

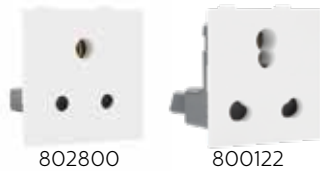

## Dimmers and Fan Regulators: • Laser Marking for Easy Identification

HSN Code: 8538 & 8414

Cat. Nos.	Description	Module	MRP ₹ / Unit	Pack
800143	Light Dimmer 400W	1	466	1/10/100
800141	Fan 4 Step Regulator 100W ( ISI Mark)	1	442	1/10/100
800142	Fan 4 step Regulator 100W ( ISI Mark)	2	548	1/10/100
800139	Fan 8 step Regulator 100W (ISI Mark)	2	674	1/10/100



## Skirting Light

HSN Code: 8536

Cat. Nos.	Description	Module	MRP ₹ / Unit	Pack
800155	Skirting Light	2	450	1/5/25



## Indicator

HSN Code: 8536

Cat. Nos.	Description	Module	MRP ₹ / Unit	Pack
800154	Flat Indicator Red	1	132	1/20/100



## Buzzer

HSN Code: 8536

Cat. Nos.	Description	Module	MRP ₹ / Unit	Pack
800140	Buzzer - 230V	1	334	1/20/100



## Bell Call Indicator

HSN Code: 8536

Cat. Nos.	Description	Module	MRP ₹ / Unit	Pack
800144	Bell Call Indicator	1	712	1/20/100



# ELVIRA

## Sockets and Connectors



### TV Socket

HSN Code: 8536

	Cat. Nos.	Description	Module	MRP ₹ / Unit	Pack
 800132	800132	TV Socket	1	114	1/20/100

### Data & Voice

HSN Code: 8536

	Cat. Nos.	Description	Module	MRP ₹ / Unit	Pack
 800130	800130	Telephone Socket - RJ11	1	118	1/20/100
 800131	800131	Computer Socket- RJ45 Cat 6	1	292	1/20/100

## Protectors and Accessories

### Motor Starter



HSN Code: 8536

	Cat. Nos.	Description	Module	MRP ₹ / Unit	Pack
 800196	800196	25A Motor Starter	2	544	1/10/50

## MCB: (IS : 608981:2002) • Laser Marking

### Modular MCB

HSN Code: 8536

	Cat. Nos.	Description	Module	MRP ₹ / Unit	Pack
 800160	800160	16A MINI MCB SP C CURVE	1	484	1/10/100
 800156	800191	20A MINI MCB SP C CURVE	1	484	1/10/100
	800156	25A MINI MCB SP C CURVE	1	484	1/10/100
	800157	32A MINI MCB SP C CURVE	1	484	1/10/100

### Power Unit

HSN Code: 8536

	Cat. Nos.	Description	Module	MRP ₹ / Unit	Pack
 800193	800193	Power Unit with 20A MCB & 16A PLUG	3	1,142	1/10
	800194	Power Unit with 25A MCB & 16A PLUG	3	1,226	1/10

## Electronic Function (IS13252 (Part 1) / IEC 60950-1) • CRS Certified

### USB Chargers

HSN Code: 8536

	Cat. Nos.	Description	Module	MRP ₹ / Unit	Pack
 800145	800145	USB charger 1500mA Type A	1	1,066	1/10/100

# ELVIRA

## Hospitality Function

### Hotel Keycard Switch

HSN Code: 8538

	Cat. Nos.	Description	Module	MRP ₹ / Unit	Pack
 800197	800197	Key card Switch 15A	2	2,722	1/1/10



### Hotel "DND and MMR" Functions

HSN Code: 8538

	Cat. Nos.	Description	Module	MRP ₹ / Unit	Pack
 800192	800192	DND INTERNAL UNIT	2	234	1/10/100
	800195	DND EXTERNAL UNIT	2	278	1/10/100

### Accessories





HSN Code: 8538

	Cat. Nos.	Description	Module	MRP ₹ / Unit	Pack
 800151	800151	1 Module Blank Plate	1	30	1/20/200
 800153	800152	2 Module Blank plate	2	56	1/10/100
	800153	Cable Outlet	1	94	1/20/100

## Plate & Frame: • Strong Dimensional Stability

### Elvira Double Plates White





HSN Code: 8538

	Cat. Nos.	Description	Module	MRP ₹ / Unit	Pack
 800161	800161	White Plate + Frame, 1M	1	98	1/10/100
	800162	White Plate + Frame, 2M	2	98	1/10/100
 800163	800163	White Plate + Frame, 3M	3	136	1/10/100
	800164	White Plate + Frame, 4M	4	156	1/10/100
 800166	800166	White Plate + Frame, 6M	6	202	1/10/100
	800167	White Plate + Frame, 8M (Vertical)	8	280	1/5/25
	800168	White Plate + Frame, 8M (Horizontal)	8	278	1/10/100
 800170	800165	White Plate + Frame, 12M	12	374	1/5/25
	800169	White Plate + Frame, 16M	16	414	1/5/25
	800170	White Plate + Frame, 18M	18	500	1/5/25

# ELVIRA





## Metal Flush Boxes

HSN Code: 8538

		Cat. Nos.	Description	Module	MRP ₹ / Unit	Pack
		800172	Metal Flush Box, 1/2 Module	1/2	78	40
		800174	Metal Flush Box, 4 Module	4	120	40
		800176	Metal Flush Box, 6 Module	6	180	20
		800177	Metal Flush Box, 8 Module (vertical)	8	232	20
		800178	Metal Flush Box, 8 Module	8	232	20
		810867	Metal Flush Box, 9 Module	9	278	20
		800175	Metal Flush Box, 12 Module	12	304	10
		800179	Metal Flush Box, 16 Module	16	350	10
		800180	Metal Flush Box, 18 Module	18	382	10

## Plastic Surface Boxes

HSN Code: 8538

		Cat. Nos.	Description	Module	MRP ₹ / Unit	Pack
		800182	Plastic Surface Box, 1/2 Module	1/2	80	50
		800184	Plastic Surface Box, 4 Module	4	116	25
		800186	Plastic Surface Box, 6 Module	6	176	10
		800187	Plastic Surface Box, 8 Module (vertical)	8	240	15
		800188	Plastic Surface Box 8 Module	8	240	10
		800185	Plastic Surface Box, 12 Module	12	302	10
		800189	Plastic Surface Box, 16 Module	16	352	10
		800190	Metal Surface Box, 18 Module	18	392	10

## Dimensions

### Cover Plates-**ELVIRA**

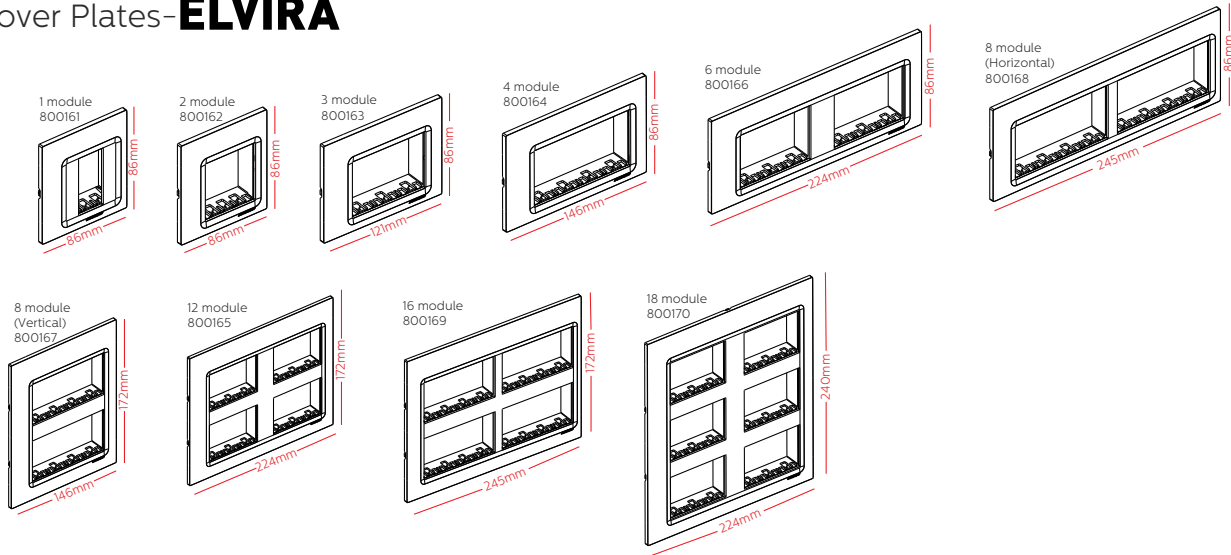

### Flush Boxes-Metal

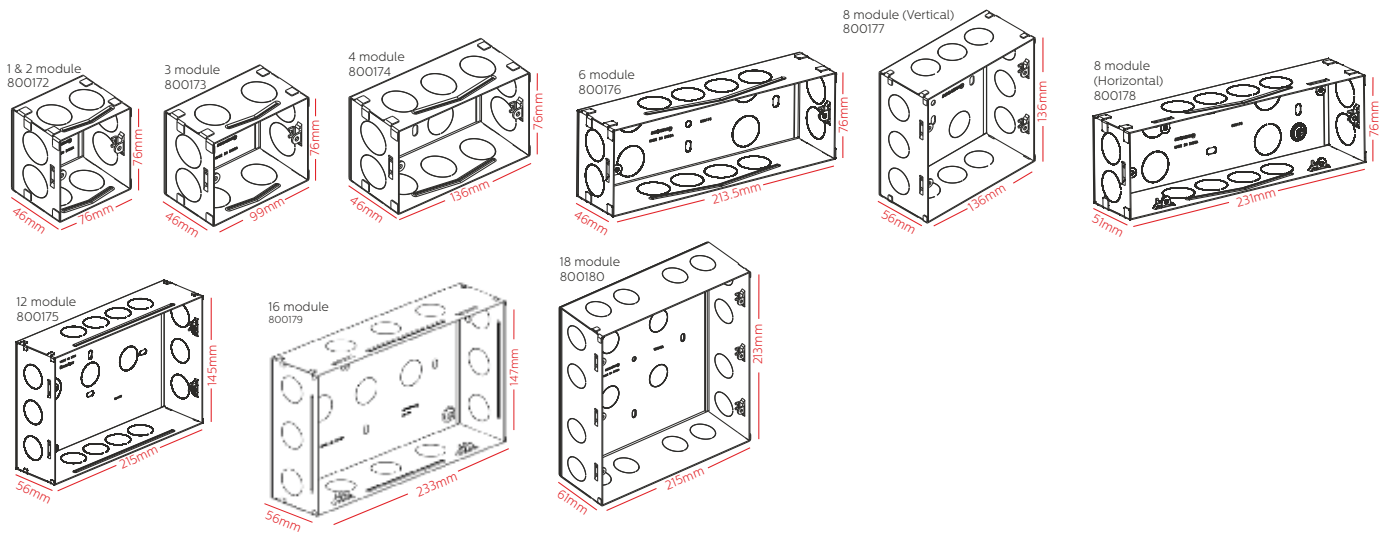

### Surface Boxes-Plastic

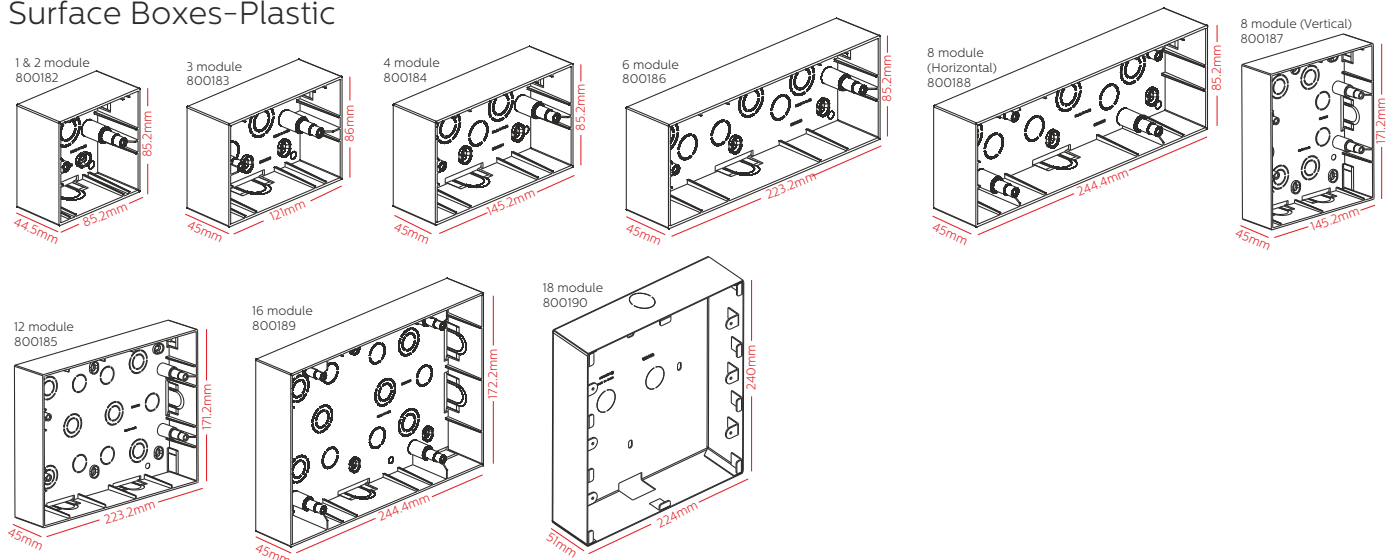

## Where design meets safety



Scan to know more about the product

**Doorsta** doorbells are designed for clear sound. Built with high quality components, they provide dependable performance for residential and commercial spaces.

### Features

- Made in India - BIS & RoHS compliant doorbell build for environmental safe usage
- Over current protection for consistent performance; works on 240 V AC
- Clear and audible chime for easy notification

### Benefits

- Enhances safety for your home with stylish design
- Easy installation and operation
- Reliable performance for everyday use

# Doorsta

## Ding Dong Doorbell

• High Sound Output • BIS / RoHS Compliant • With Over Current Protection

**HSN Code: 8536**



Cat. Nos.	Description	MRP ₹ / Unit	Pack
698450	Doorsta Ding Dong Doorbell ( BIS)	466	1/20
698451	Doorsta Ding Dong Doorbell ( BIS)	492	1/20

## 3 Pin Plugs With Easy Grip

• White Matt Finish • ISI Marked

**HSN Code: 8536**



Cat. Nos.	Description	MRP ₹ / Unit	Pack
698470	6A 3 Pin Plug (ISI mark)	108	20/200
698471	16A 3 Pin Plug (ISI mark)	162	10/100

## A range to match your needs



Scan to know more  
about the product

**Zosta** exhaust and axial fans are designed for efficient ventilation & quiet operation ensuring calm and comfortable environment.

### Features

- Aerodynamic blade design for high air delivery and efficient airflow
- Powerful copper motor for better current carrying capacity and longer life
- RoHS compliant construction
- Silent operation

### Benefits





- Improves air quality by quickly removing smoke, fumes and odours
- Long lasting durability with rust free plastic body
- Offers hassle free installation & maintenance

# Zosta™

## Exhaust Fan - White / Black

• Copper Motor • RoHS Compliant • Rust Free Body • Silent Operation

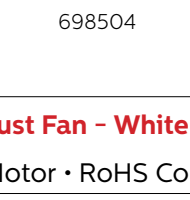

HSN Code: 8536

	Cat. Nos.	Description	MRP ₹ / Unit	Pack
 698500	698500	Exhaust Fan 150mm White	2438	1/6
 698501	698501	Exhaust Fan 200mm White	2732	1/6
 698502	698502	Exhaust Fan 250mm White	3120	1/6
 698503	698503	Exhaust Fan 150mm Black	2438	1/6
 698504	698504	Exhaust Fan 200mm Black	2732	1/6
 698505	698505	Exhaust Fan 250mm Black	3120	1/6

## Axial Exhaust Fan - White

• Copper Motor • RoHS Compliant • Rust Free Body • Silent Operation

HSN Code: 8536

	Cat. Nos.	Description	MRP ₹ / Unit	Pack
 698506	698506	Axial Exhaust Fan 100mm White	1718	1/20
 698507	698507	Axial Exhaust Fan 150mm White	1876	1/20

Bright ideas for happy & safe living



Scan to know more about the product

**Bulb Holders** are designed to provide a secure connection point for ceiling mounted lighting fixtures. Crafted from tough and lightweight material, it ensures durability while maintaining an attractive finish.

## Features

- Long lasting polycarbonate plastic
- Ducts for heat dissipation
- Metal ring prevents deformation from overheating
- ISI certified bulb holders. All products are RoHS compliant

## Benefits

- Ensures safe electrical connections for ceiling light fixtures
- Enhances aesthetics through glossy, dust resistant white finish
- Quick and easy installation

# BULB HOLDER & CEILING ROSE

## Fancy Batten Bulb Holder / Ceiling Rose

• Dynamic Design • Metal Ring Avoids Deformation

HSN Code: 8536

	Cat. Nos.	Description	MRP ₹ / Unit	Pack
 <p>698473      698474      698475</p>	698473	Fancy Batten Bulb Holder White (ISI mark)	90	20/200
	698474	Fancy Angle Bulb Holder White (ISI mark)	90	20/200
	698475	Fancy Ceiling Rose White	58	20/200

## Experience happiness through safe and secure products



Scan to know more about the product

**Caretron** ensures complete safety for your home by protecting against electrical faults. Designed for modern homes, it delivers reliable and worry-free power every day.

### Features

- ISI / CE certified as per IS/IEC 60898-1 standards
- Bi-connect terminals for cable / busbar connection with positive isolation
- 6kA breaking capacity with IP 20 degree of Protection

### Benefits

- Enhances electrical safety by preventing damage from overloads and short circuits
- Ensures reliable electrical performance by disconnecting faulty circuits
- Hassle-free maintenance & long-term reliability

# Caretron™

## Caretron Miniature Circuit Breaker

- ISI / CE Marked as per IS/IEC 60898 -1 • Degree of Protection IP 20 • Bi-Connect Terminals • 25 sq. mm Terminals
- Breaking Capacity 6kA



### B Curve Single Pole

HSN Code: 8536

	Rating (A)	Pack*	Item Number	MRP ₹ / Unit
	6	1/12/180	810000	246
	10	1/12/180	810001	246
	16	1/12/180	810002	246
	20	1/12/180	810003	246
	25	1/12/180	810004	246
	32	1/12/180	810005	246
	40	1/12/180	810006	560
	50	1/12/180	810007	628
	63	1/12/180	810008	628

### B Curve Single Pole Neutral

HSN Code: 8536

	Rating (A)	Pack*	Item Number	MRP ₹ / Unit
	6	1/6/90	810009	829
	10	1/6/90	810010	829
	16	1/6/90	810011	829
	20	1/6/90	810012	829
	25	1/6/90	810013	829
	32	1/6/90	810014	829
	40	1/6/90	810015	1216
	50	1/6/90	810016	1345
	63	1/6/90	810017	1345

# Caretron™

## B Curve Double Pole

HSN Code: 8536



810018

810019

Rating (A)	Pack*	Item Number	MRP ₹ / Unit
6	1/6/90	810018	866
10	1/6/90	810019	866
16	1/6/90	810020	866
20	1/6/90	810021	866
25	1/6/90	810022	866
32	1/6/90	810023	866
40	1/6/90	810024	1278
50	1/6/90	810025	1429
63	1/6/90	810026	1429

## C Curve Single Pole

HSN Code: 8536



810054

810055

Rating (A)	Pack*	Item Number	MRP ₹ / Unit
6	1/12/180	810054	248
10	1/12/180	810055	248
16	1/12/180	810056	248
20	1/12/180	810057	248
25	1/12/180	810058	248
32	1/12/180	810059	248
40	1/12/180	810060	574
50	1/12/180	810061	668
63	1/12/180	810062	668

# Caretron™

## Caretron Miniature Circuit Breaker

- ISI / CE Marked as per IS/IEC 60898 -1 • Degree of Protection IP 20 • Bi-Connect Terminals • 25 sq. mm Terminals
- Breaking Capacity 6kA

### C Curve Single Pole Neutral

HSN Code: 8536



	Rating (A)	Pack*	Item Number	MRP ₹ / Unit
	6	1/6/90	810063	916
	10	1/6/90	810064	916
	16	1/6/90	810065	916
	20	1/6/90	810066	916
	25	1/6/90	810067	916
	32	1/6/90	810068	916
	40	1/6/90	810069	1289
	50	1/6/90	810070	1523
	63	1/6/90	810071	1523

810063

810064

### C Curve Double Pole

HSN Code: 8536

	Rating (A)	Pack*	Item Number	MRP ₹ / Unit
	6	1/6/90	810072	925
	10	1/6/90	810073	925
	16	1/6/90	810074	925
	20	1/6/90	810075	925
	25	1/6/90	810076	925
	32	1/6/90	810077	925
	40	1/6/90	810078	1372
	50	1/6/90	810079	1549
	63	1/6/90	810080	1549

810072

810073

# Caretron™

## C Curve Three Pole

HSN Code: 8536



810081

Rating (A)	Pack*	Item Number	MRP ₹ / Unit
6	1/4/60	810081	1514
10	1/4/60	810082	1514
16	1/4/60	810083	1514
20	1/4/60	810084	1514
25	1/4/60	810085	1514
32	1/4/60	810086	1514
40	1/4/60	810087	2161
50	1/4/60	810088	2378
63	1/4/60	810089	2378

## C Curve Three Pole Neutral

HSN Code: 8536



810090

Rating (A)	Pack*	Item Number	MRP ₹ / Unit
6	1/3/45	810090	1998
10	1/3/45	810091	1998
16	1/3/45	810092	1998
20	1/3/45	810093	1998
25	1/3/45	810094	1998
32	1/3/45	810095	1998
40	1/3/45	810096	2689
50	1/3/45	810097	2928
63	1/3/45	810098	2928

# Caretron™

## C Curve Four Pole

HSN Code: 8536



810099

Rating (A)	Pack*	Item Number	MRP ₹ / Unit
6	1/3/45	810099	2017
10	1/3/45	810100	2017
16	1/3/45	810101	2017
20	1/3/45	810102	2017
25	1/3/45	810103	2017
32	1/3/45	810104	2017
40	1/3/45	810105	2717
50	1/3/45	810106	2974
63	1/3/45	810107	2974

## Isolator

- Conforms to IEC 60947-3 • Bi-Connect Terminals • Positive Isolation • Degree of Protection IP 20
- 25 sq. mm Terminals

## Double Pole



810131

Rating (A)	Pack*	Cat. Nos.	MRP ₹ / Unit
40	1/6/90	810130	614
63	1/6/90	810131	758

## Three Pole

HSN Code: 8536



810132

Rating (A)	Pack*	Cat. Nos.	MRP ₹ / Unit
40	1/4/60	810132	1102
63	1/4/60	810133	1236

\*Subject to Change Based on Packaging Type

## Four Pole

HSN Code: 8536



810134

Rating (A)	Pack	Cat. Nos.	MRP ₹ / Unit
40	1/3/45	810134	1364
63	1/3/45	810135	1429

# Caretron™

## Residual Current Circuit Breaker - RCCB

- ISI/CE marked as per IS/IEC12640 • Rated Conditional Short Circuit Current, ICC6kA • Degree of Protection IP 20
- Bi-Connect Terminals • 25 sq. mm Terminals

### Double Pole

HSN Code: 8536

		Rating (A)	Sensitivity	Pack	Cat. Nos.	MRP ₹ / Unit
 <p>810150                      810153</p>		25	30 mA	1/6/90	810150	3255
		25	100 mA	1/6/90	810153	3401
		25	300 mA	1/6/90	810156	3401
		40	30 mA	1/6/90	810151	3606
		40	100 mA	1/6/90	810154	3663
		40	300 mA	1/6/90	810157	3663
		63	30 mA	1/6/90	810152	4594
		63	100 mA	1/6/90	810155	4644
		63	300 mA	1/6/90	810158	4644

### Four Pole

HSN Code: 8536

		Rating (A)	Sensitivity	Pack	Cat. Nos.	MRP ₹ / Unit
 <p>810159                      810162</p>		25	30 mA	1/3/45	810159	4264
		25	100 mA	1/3/45	810162	4386
		25	300 mA	1/3/45	810165	4386
		40	30 mA	1/3/45	810160	4353
		40	100 mA	1/3/45	810163	4477
		40	300 mA	1/3/45	810166	4477
		63	30 mA	1/3/45	810161	4837
		63	100 mA	1/3/45	810164	4911
		63	300 mA	1/3/45	810167	4911

— optipro™ —

ALL THAT YOU NEED

**INDOASIAN**   
MAKES SENSE

Engineered to perfection with  
a wide range and unmatched  
quality



Scan to know more  
about the product

**Optipro MCBs** are designed to provide protection for circuits in residential, commercial & industrial installations. These ranges safeguard electrical systems from overloads and short circuits.

### Features

- Designed to perform in extreme conditions
- Visual status window (Red-ON/Green-OFF) for contact position
- Bi connect terminal with large terminal size

### Benefits

- Protects against Overload and Short Circuit
- Simple clip-on mechanism that allows for quick and easy installation
- IP 20 degree protection ensures no live parts are exposed

# —optipro™—

## Miniature Circuit Breaker - MCB

- Conforms to IS/IEC 60898 • Short-Circuit Breaking Capacity 10kA • Line Load Reversibility • 35 sq. mm Terminals
- Biconnect Terminals • Frequency: 50 Hz • Clear Visual Indication of Contact Position

### B Curve Single Pole

HSN Code: 8536

	Rating (A)	Pack	Cat. Nos.	MRP ₹ / Unit
 <p>811010                      811012</p>	6	1/12/180	811008	317
	10	1/12/180	811010	317
	16	1/12/180	811012	317
	20	1/12/180	811013	317
	25	1/12/180	811014	317
	32	1/12/180	811015	317
	40	1/12/180	811016	736
	50	1/12/180	811017	851
	63	1/12/180	811018	851

### B Curve Single Pole Neutral

HSN Code: 8536

	Rating (A)	Pack	Cat. Nos.	MRP ₹ / Unit
 <p>811027                      811033</p>	6	1/6/90	811027	1082
	10	1/6/90	811029	1082
	16	1/6/90	811031	1082
	20	1/6/90	811032	1082
	25	1/6/90	811033	1082
	32	1/6/90	811034	1082
	40	1/6/90	811035	1528
	50	1/6/90	811036	1733
	63	1/6/90	811037	1733

# —optipro™—

## B Curve Double Pole

HSN Code: 8536



811046

811048

Rating (A)	Pack	Cat. Nos.	MRP ₹ / Unit
6	1/6/90	811046	1124
10	1/6/90	811048	1124
16	1/6/90	811050	1124
20	1/6/90	811051	1124
25	1/6/90	811052	1124
32	1/6/90	811053	1124
40	1/6/90	811054	1635
50	1/6/90	811055	1821
63	1/6/90	811056	1821

## Optipro Isolator

- Conforms to IEC 60947-3 • CE Marked • Degree of Protection IP 20 • Large Terminal Size -35sqmm
- Biconnect Terminals

## Double Pole

HSN Code: 8536



811552

Rating (A)	Pack	Cat. Nos.	MRP ₹ / Unit
80	1/6/90	811552	1139
100	1/6/90	811553	1139
125	1/6/90	811554	1228

## Three Pole

HSN Code: 8536



811557

Rating (A)	Pack	Cat. Nos.	MRP ₹ / Unit
80	1/4/60	811557	1723
100	1/4/60	811558	1723
125	1/4/60	811559	1891

—optipro™—

**Four Pole**

HSN Code: 8536



811563

Rating (A)	Pack	Cat. Nos.	MRP ₹ / Unit
80	1/3/45	811562	2139
100	1/3/45	811563	2139
125	1/3/45	811564	2314

**Automatic Changeover with Current Limiter**

• As per IEC60947-6-1 • Intelligent Micro Controller Based Design • RoHS Compliant

HSN Code: 8536



810400



810401

Rating (A)	Pack	Cat. Nos.	MRP ₹ / Unit
SPN 30A Mains 1.5A DG ACCL	1/3/45	810409	2608
SPN 30A Mains 2.5A DG ACCL	1/3/45	810410	2608
SPN 30A Mains 3A DG ACCL	1/3/45	810400	2608
SPN 30A Mains 4A DG ACCL	1/3/45	810401	2608
SPN 30A Mains 5A DG ACCL	1/3/45	810402	2608
SPN 30A Mains 6A DG ACCL	1/3/45	810403	2608
SPN 30A Mains 9A DG ACCL	1/3/45	810404	2608
SPN 30A Mains 12A DG ACCL	1/3/45	810405	2608
SPN 30A Mains 15A DG ACCL	1/3/45	810406	2608
SPN 30A Mains 20A DG ACCL	1/3/45	810407	2608
SPN 30A Mains 30A DG ACCL	1/3/45	810408	2608

## Attractive design with minimal wall projection and matt finish



Scan to know more about the product

**Caretron+** Distribution Boards are designed for superior safety, durability, and modern aesthetics. A perfect blend of performance and design for residential and commercial spaces.

### Features

- Degree of Protection: IP 30 & IP 42
- Enhanced safety: Door earthing, Option for shrouding neutral links
- Wide range with SPN/TPN/VTPN/Phase Selector DBs
- Easy installation: insertion marks, key holes, ample wiring space

### Benefits

- Fast, hassle-free installation and easy maintenance with ample space and clear circuit labels
- Enhances the visual appeal of interiors with a sleek and modern distribution board design
- Long service life with enhanced durability and corrosion resistance

# Caretron™ +

## CARETRON+ Distribution Boards

- Innovative Design with Minimal Wall Projection • Degree of Protection IP 30 and IP42 • Mechanical Impact Strength IK 08 • Suitable for Surface and Flush Mounting • Detachable Gland Plate • Box Insertion Marks
- Attractive White Shade (RAL 9010) Matt Finish • Circuit Identification Label

### SPN Single Door

HSN Code: 8537



8105001

No. of Way	Incomer + Outgoing	Pack	Cat. Nos.	MRP ₹ / Unit
4	4	1/19	8105001	1099
6	6	1/18	8105011	1219
8	8	1/13	8105021	1366
12	12	1/11	8105031	1865
16	16	1/9	8105041	2295

### SPN Double Door

HSN Code: 8537



810505

No. of Way	Incomer + Outgoing	Pack	Cat. Nos.	MRP ₹ / Unit
4	4	1/14	810505	1925
6	6	1/12	810506	2116
8	8	1/10	810507	2347
12	12	1/9	810508	2831
16	16	1/7	810509	3483

# Caretron™ +

## TPN Single Door

HSN Code: 8537



8105121

No. of Way	Incomer + Outgoing	Pack	Cat. Nos.	MRP ₹ / Unit
4	4+12	1/8	8105101	3296
4	8+12	1/5	8105111	3732
6	4+18	1/5	8105121	3964
6	8+18	1/5	8105131	4538
8	8+24	1/4	8105141	5179
12	8+36	1/4	8105151	6978

## TPN Double Door

HSN Code: 8537



810516

No. of Way	Incomer + Outgoing	Pack	Cat. Nos.	MRP ₹ / Unit
4	4+12	1/6	810516	4606
4	8+12	1/4	810517	4785
6	4+18	1/4	810518	5434
6	8+18	1/3	810519	5716
8	8+24	1/3	810520	6894
12	8+36	1/3	810521	8465

# Caretron™ +

## CARETRON+ Distribution Boards

• Innovative Design with Minimal Wall Projection • Degree of Protection IP 30 AND IP42 • Mechanical Impact Strength IK 08 • Suitable for Surface and Flush Mounting • Detachable Gland Plate • Attractive White Shade (RAL 9010) Matt Finish • Box Insertion Marks • Circuit Identification Label

### VTPN MCB Incomer Double Door

HSN Code: 8537

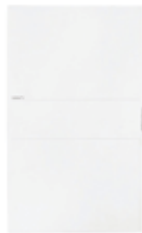

810526

No. of Way	Incomer + Outgoing	Pack	Cat. Nos.	MRP ₹ / Unit
4	8+12	1	810526	11176
6	8+18	1	810527	13097
8	8+24	1	810528	14589
12	8+36	1	810529	19281

### VTPN 125A MCCB I/C DD DB

HSN Code: 8537



810530

No. of Way	Incomer + Outgoing	Pack	Cat. Nos.	MRP ₹ / Unit
4	Optium F1 + 12	1	810530	12917
6	Optium F1 + 18	1	810531	14185
8	Optium F1 + 24	1	810532	15447
12	Optium F1 + 36	1	810533	19350

### VTPN 250A MCCB I/C DD DB

HSN Code: 8537



810534

No. of Way	Incomer + Outgoing	Pack	Cat. Nos.	MRP ₹ / Unit
4	Optium F2 + 12	1	810534	16718
6	Optium F2 + 18	1	810535	18364
8	Optium F2 + 24	1	810536	19314
12	Optium F2 + 36	1	810537	24195

### Phase Selector 40A Double Door (Pre Fitted Selector Switches)

HSN Code: 8536



810546

No. of Way	Incomer + Outgoing	Pack	Cat. Nos.	MRP ₹ / Unit
4	8 + 12	1	810546	12594
6	8 + 18	1	810547	13790
8	8 + 24	1	810548	14463
12	8 + 36	1	810549	16538

# Caretron™ +

## Phase Selector 63A Double Door (Pre Fitted Selector Switches)

HSN Code: 8536



No. of Way	Incomer + Outgoing	Pack	Cat. Nos.	MRP ₹ / Unit
4	8 + 12	1	810550	15114
6	8 + 18	1	810551	15830
8	8 + 24	1	810552	16536
12	8 + 36	1	810553	19324

## Plug & Socket Box

HSN Code: 8536



No. of Way	Incomer + Outgoing	Pack	Cat. Nos.	MRP ₹ / Unit
20A TP (compatible with 20A TP 'C' MCB) Metal Box	3	1/8	8105561	2924
32A TP (compatible with 32A TP 'C' MCB) Metal Box	3	1/8	8105571	4074
20A SP (supplied with 20A SP 'C' MCB) Metal Box	1	1/24	8105581	1350
20A DP (supplied with 20A DP 'C' MCB) Metal Box	2	1/24	8105591	1798

## Metal Enclosure

HSN Code: 8537



No. of Way	Incomer + Outgoing	Pack	Cat. Nos.	MRP ₹ / Unit
1	1	1/50	8105601	531
2	2	1/36	8105611	531
3	3	1/36	8105621	620
4	4	1/32	8105631	620
6	6	1/24	8105641	741

## Plastic Enclosure

HSN Code: 8536



No. of Way	Incomer + Outgoing	Pack	Cat. Nos.	MRP ₹ / Unit
1 & 2	1/2	1/5/45	810565	129
3 & 4	3/4	1/3/27	810566	204

# Caretron™ +

## Busbar Chamber

- Solution for Safe Power Distribution • Step Type Design • Available in Both SPN & TPN Configuration
- Also Available in IP54 Design

### TPN BBC (CU-Busbar)

HSN Code: 8536



CPPI1015

Item Description	Ingress Protection*	Cat. Nos.	MRP ₹ / Unit
Spl. 32A TPN BBC (Cu) with 4 o/g ways	IP42	CPPI1015	10130
Spl. 63A TPN BBC (Cu) with 4 o/g ways	IP42	CPPI1016	11290
Spl. 100A TPN BBC (Cu) with 4 o/g ways	IP42	CPPI1017	12510
Spl. 200A TPN BBC (Cu) with 4 o/g ways	IP42	CPPI1018	15480
Spl. 250A TPN BBC (Cu) with 4 o/g ways	IP42	CPPI1019	22030
Spl. 320A TPN BBC (Cu) with 4 o/g ways	IP42	CPPI1020	26760
Spl. 400A TPN BBC (Cu) with 4 o/g ways	IP42	CPPI1021	29740
Spl. 630A TPN BBC (Cu) with 4 o/g ways	IP42	CPPI1022	47570

## Busbar Chamber

- Solution for Safe Power Distribution • Step Type Design
- Available in Both SPN & TPN Configuration • Also Available in IP54 Design

### TPN-Type (Al.Busbar)

HSN Code: 8536



CPPI1023

Item Description	Ingress Protection*	Cat. Nos.	MRP ₹ / Unit
Spl. 32A TPN BBC (Al.) with 4 o/g ways	IP42	CPPI1023	9520
Spl. 63A TPN BBC (Al.) with 4 o/g ways	IP42	CPPI1024	10130
Spl. 100A TPN BBC (Al.) with 4 o/g ways	IP42	CPPI1025	10680
Spl. 200A TPN BBC (Al.) with 4 o/g ways	IP42	CPPI1026	11290
Spl. 250A TPN BBC (Al.) with 4 o/g ways	IP42	CPPI1027	13650
Spl. 320A TPN BBC (Al.) with 4 o/g ways	IP42	CPPI1028	14870
Spl. 400A TPN BBC (Al.) with 4 o/g ways	IP42	CPPI1029	15480
Spl. 630A TPN BBC (Al.) with 4 o/g ways	IP42	CPPI1008	26600

# Caretron™ +

## MCCB Enclosure

• Solid Neutral Link for 3 Pole MCCBs

HSN Code: 8537



811985

Description	Pack	Cat. Nos.	MRP ₹ / Unit
Optipro Enclosure for Frame-1 Optium 3 Pole MCCB	1	811984	2335
Optipro Enclosure for Frame-1 Optium 4 Pole MCCB	1	811985	2335
Optipro Enclosure for Frame-2 Optium 3 Pole MCCB	1	811986	3517
Optipro Enclosure for Frame-2 Optium 4 Pole MCCB	1	811987	3517
Optipro Enclosure for Frame-3 Optium 3 Pole MCCB	1	811988	3517
Optipro Enclosure for Frame-3 Optium 4 Pole MCCB	1	811989	3517
Optipro Enclosure for Frame-4 Optium 3 Pole MCCB	1	811990	8753
Optipro Enclosure for Frame-4 Optium 4 Pole MCCB	1	811991	8753

## Metal Clad Plug & Socket

### AC Plug

HSN Code: 8536



811985

Rating	Pack	Cat. Nos.	MRP ₹ / Unit
10A 2P+E, 230V AC	1/10/100	810385	212
20A 2P+E, 230V AC	1/10/100	810386	227
20A 3P+E, 230V / 415V AC	1/10/100	810387	309
32A 3P+E, 230V / 415V AC	1/10/100	810388	557

### AC Socket

HSN Code: 8537



810389

Rating	Pack	Cat Ref.	MRP ₹ / Unit
10A 2P+E, 230V AC	1/10/100	810389	212
20A 2P+E, 230V AC	1/10/100	810390	244
20A 3P+E, 230V / 415V AC	1/10/100	810391	322
32A 3P+E, 230V / 415V AC	1/10/100	810392	557

# Caretron™ +

## Time Switches

HSN Code: 9107



TA916422

Model Name	Description	Cat Ref.	MRP ₹ / Unit
1mod DIN Daily	1P Module, 24 hours program, Programmable every 15 min., backup of 100 hours, current capacity 16A, with 1 changeover (1 CO)	TA916422	5038
3mod DIN Daily	"3P Module, 24 hours program, Programmable every 15 min., backup of 100 hrs., current capacity 16A, with 1 changeover (1 CO)"	TA926453	5489
"DIN Type Daily / Weekly with 1 CO"	"Programmable every 1 min., with backup of 6 years, 28 memory locations, current capacity 16A, weekly program, with 1 changeover (1 CO), Total 28 program"	TDA43110	6670

\* For other models of Time Switches please contact nearest Branch Office.

# Ensuring reliable performance at high ambient & humid environments



Scan to know more about the product

**Optium** MCCBs represent advanced MCCB technology, delivering intelligent protection, robust performance, and a wide range of options for complex electrical infrastructure, ensuring adaptability, safety, and durability.

## Features

- Delivers breaking capacities ranging from 10kA – 50kA
- Wide range from 16A – 250A in compact frames and up to 1250A in larger frames
- Multiple series of ranges with fine-tunable protection settings

## Benefits



- Offers reliable protection against overloads, short circuits, and ground faults across a wide performance range
- Flexibility in system design using adjustable settings and multiple frames
- Improved uptime and easier maintenance through long mechanical/electrical endurance

**optium™**  
ALL THAT YOU NEED  
MCCB





**Optium 1.0 (Fixed TM MCCB Range)**

• Ics =50% Icu as per IEC 60947-II • Suitable for Isolation Fixed Overload & Fixed Short Circuit Setting

**HSN Code: 8536**

	Frame	Breaking Capacity	Rating	3P	MRP ₹ / Unit	4P	MRP ₹ / Unit
 830701	F1	10kA	16	830701	3470	830710	4210
 830702	F1	10kA	25	830702	3470	830711	4210
	F1	10kA	32	830703	3470	830712	4210
	F1	10kA	40	830704	3470	830713	4210
	F1	10kA	50	830705	3470	830714	4210
	F1	10kA	63	830706	3470	830715	4210
	F1	10kA	80	830707	3910	830716	5000
	F1	10kA	100	830708	3920	830717	5020
	F1	10kA	125	830709	5600	830718	7230

**HSN Code: 8536**

	Frame	Breaking Capacity	Rating	3P	MRP ₹ / Unit	4P	MRP ₹ / Unit
 830001	F1	16kA	16	830001	5770	830015	7050
 830003	F1	16kA	25	830002	5770	830016	7050
	F1	16kA	32	830003	5770	830017	7050
	F1	16kA	40	830004	5770	830018	7050
	F1	16kA	50	830005	5770	830019	7050
	F1	16kA	63	830006	5770	830020	7050
	F1	16kA	80	830007	6060	830021	7800
	F1	16kA	100	830008	6060	830022	7800
 830015							
 830016							
	F1	16kA	125	830009	8390	830023	11030

**optium™**  
ALL THAT YOU NEED  
MCCB

**Optium 1.0 (Fixed TM MCCB Range)**

HSN Code: 8536



830031



830032



830034



830035

Frame	Breaking Capacity	Rating	3P	MRP ₹ / Unit	4P	MRP ₹ / Unit
F1	25kA	16	830031	6950	830045	8300
F1	25kA	25	830032	6950	830046	8300
F1	25kA	32	830033	6950	830047	8300
F1	25kA	40	830034	6950	830048	8300
F1	25kA	50	830035	6950	830049	8300
F1	25kA	63	830036	6950	830050	8300
F1	25kA	80	830037	7150	830051	8710
F1	25kA	100	830038	7150	830052	8710
F1	25kA	125	830039	8610	830053	11460

**Optium 1.0 (Fixed TM MCCB Range)**

HSN Code: 8536



830061



830062



830063







830064

Frame	Breaking Capacity	Rating	3P	MRP ₹ / Unit	4P	MRP ₹ / Unit
F1	36kA	16	830061	9190	830075	10510
F1	36kA	25	830062	9190	830076	10510
F1	36kA	32	830063	9190	830077	10510
F1	36kA	40	830064	9190	830078	10510
F1	36kA	50	830065	9190	830079	10510
F1	36kA	63	830066	9190	830080	10510
F1	36kA	80	830067	9330	830081	11080
F1	36kA	100	830068	9330	830082	11080
F1	36kA	125	830069	12860	830083	13370

**optium™**  
ALL THAT YOU NEED  
MCCB

**Optium 1.0 (Fixed TM MCCB Range)**

HSN Code: 8536

		Frame	Breaking Capacity	Rating	3P	MRP ₹ / Unit	4P	MRP ₹ / Unit
		F3	50kA	16	830125	10630	830145	12930
		F3	50kA	25	830126	10630	830146	12930
		F3	50kA	32	830127	10630	830147	12930
		F3	50kA	40	830128	10630	830148	12930
		F3	50kA	50	830129	10630	830149	12930
		F3	50kA	63	830130	10630	830150	12930
		F3	50kA	80	830131	11170	830151	13320
		F3	50kA	100	830132	11170	830152	13320
		F3	50kA	125	830133	13030	830153	16520



HSN Code: 8536

		Frame	Breaking Capacity	Rating	3P	MRP ₹ / Unit	4P	MRP ₹ / Unit
		F2	16kA	160	830090	8970	830095	13010
		F2	16kA	200	830091	11610	830096	15110
		F2	16kA	250	830092	12810	830097	15960
		F2	25kA	160	830100	10610	830105	13030
		F2	25kA	200	830101	14330	830106	17340
		F2	25kA	250	830102	18490	830107	21740
		F2	36kA	160	830110	13050	830115	16000
		F2	36kA	200	830111	16720	830116	21120
		F2	36kA	250	830112	21820	830117	28700



**optium™**  
ALL THAT YOU NEED  
MCCB

**Optium 1.0 (Fixed TM MCCB Range)**

HSN Code: 8536



		Frame	Breaking Capacity	Rating	3P	MRP ₹ / Unit	4P	MRP ₹ / Unit
		F3	50kA	160	830134	14580	830154	20020
		F3	50kA	200	830135	17550	830155	24630
		F3	50kA	250	830136	22560	830156	29980

HSN Code: 8536

		Frame	Breaking Capacity	Rating	3P	MRP ₹ / Unit	4P	MRP ₹ / Unit
		F4	36kA	315	830165	29470	830175	33620
		F4	36kA	400	830166	31140	830176	35520
		F4	36kA	500	830167	34850	830177	40330
		F4	36kA	630	830168	36940	830178	42440

**Optium 1.0 (Fixed TM MCCB Range)**

HSN Code: 8536

		Frame	Breaking Capacity	Rating	3P	MRP ₹ / Unit	4P	MRP ₹ / Unit
		F4	50kA	315	830185	30330	830195	35960
		F4	50kA	400	830186	33100	830196	38840
		F4	50kA	500	830187	35990	830197	41750
		F4	50kA	630	830188	38150	830198	43260

**Optium 1.0 (Fixed TM MCCB Range)**

HSN Code: 8536









		Frame	Breaking Capacity	Rating	3P	MRP ₹ / Unit	4P	MRP ₹ / Unit
		F5	50kA	800	830200	49710	830201	64210

**optium™**  
ALL THAT YOU NEED  
MCCB

**Optium 1.1 (Fixed TM MCCB Range)**

• Ics = 100% Icu as per IEC 60947-II • Class II Front Face • Suitable for Isolation • Fixed Overload & Fixed Short Circuit Setting

**HSN Code: 8536**

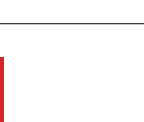
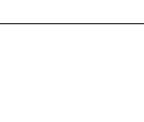
	Frame	Breaking Capacity	Rating	3P	MRP ₹ / Unit	4P	MRP ₹ / Unit
	F1	16kA	32	840003	6010	840017	7880
	F1	16kA	40	840004	6010	840018	7880
	F1	16kA	63	840006	6010	840020	7880
	F1	16kA	80	840007	6240	840021	8430
	F1	16kA	100	840008	6240	840022	8430
	F1	16kA	125	840009	8750	840023	11760
	F1	25kA	32	840033	7290	840047	9230
	F1	25kA	40	840034	7290	840048	9230
	F1	25kA	63	840036	7290	840050	9230
	F1	25kA	80	840037	7720	840051	9410
	F1	25kA	100	840038	7720	840052	9410
	F1	25kA	125	840039	8930	840053	13200
	F2	16kA	160	840090	9250	840095	13800
	F2	16kA	200	840091	11620	840096	15420
	F2	16kA	250	840092	13240	840097	17680
	F2	25kA	160	840100	10770	840105	14240
	F2	25kA	200	840101	15120	840106	18160
	F2	25kA	250	840102	19540	840107	24420





**optium™**  
ALL THAT YOU NEED  
MCCB

**Optium 2.0 (Adjustable Thermal Setting MCCB)**





• Conforms to IEC 60947-II • Ics = 100% Icu • Class II Front Face • Suitable for Isolation • Adjustable Overload

Setting Ir = (0.8 to 1.0) x In • Short Circuit Setting Fixed

**HSN Code: 8536**

Frame	Breaking Capacity	Rating	3P	MRP ₹ / Unit	4P	MRP ₹ / Unit		
 830222	 830223	F1	16kA	25	830222	6110	830236	8160
		F1	16kA	32	830223	6110	830237	8160
		F1	16kA	40	830224	6110	830238	8160
		F1	16kA	50	830225	6110	830239	8160
		F1	16kA	63	830226	6110	830240	8160
 830224	 830225	F1	16kA	80	830227	6620	830241	8770
		F1	16kA	100	830228	6620	830242	8770
		F1	16kA	125	830229	9050	830243	12230

**HSN Code: 8536**

Frame	Breaking Capacity	Rating	3P	MRP ₹ / Unit	4P	MRP ₹ / Unit		
 830252	 830253	F1	25kA	25	830252	7660	830266	9650
		F1	25kA	32	830253	7660	830267	9650
		F1	25kA	40	830254	7660	830268	9650
		F1	25kA	50	830255	7660	830269	9650
		F1	25kA	63	830256	7660	830270	9650
 830254	 830255	F1	25kA	80	830257	8040	830271	10120
		F1	25kA	100	830258	8040	830272	10120
		F1	25kA	125	830259	9310	830273	13850

**optium™**  
ALL THAT YOU NEED  
MCCB

**Optium 2.0 (Adjustable Thermal Setting MCCB)**

HSN Code: 8536



830280



830281

Frame	Breaking Capacity	Rating	3P	MRP ₹ / Unit	4P	MRP ₹ / Unit
F2	16kA	160	830280	9710	830285	14290
F2	16kA	200	830281	12100	830286	16010
F2	16kA	250	830282	14000	830287	18920
F2	25kA	160	830290	12290	830295	16120
F2	25kA	200	830291	15720	830296	20290
F2	25kA	250	830292	21020	830297	26290

**Optium 2.0 (Adjustable TM MCCB Range)**

• Ics =100% Icu as per IEC 60947-II • Class II Front Face • Suitable for Isolation • Adjustable Overload Setting

$I_r = (0.8 \text{ to } 1.0) \times I_n$  • Adjustable Short Circuit Setting  $I_{sd} = (5 - 10) \times I_n$

HSN Code: 8536



830305



830306



830307



830308

Frame	Breaking Capacity	Rating	3P	MRP ₹ / Unit	4P	MRP ₹ / Unit
F3	36kA	16	830305	9910	830325	13700
F3	36kA	25	830306	9910	830326	13700
F3	36kA	32	830307	9910	830327	13700
F3	36kA	40	830308	9910	830328	13700
F3	36kA	50	830309	9910	830329	13700
F3	36kA	63	830310	9910	830330	13700
F3	36kA	80	830311	10110	830331	14100
F3	36kA	100	830312	10110	830332	14100
F3	36kA	125	830313	13110	830333	15800

**optium™**  
ALL THAT YOU NEED  
MCCB

**Optium 2.0 (Adjustable Thermal Setting MCCB)**

HSN Code: 8536



830345



830346

Frame	Breaking Capacity	Rating	3P	MRP ₹ / Unit	4P	MRP ₹ / Unit
F3	50kA	16	830345	13350	830365	15950
F3	50kA	25	830346	13350	830366	15950
F3	50kA	32	830347	13350	830367	15950
F3	50kA	40	830348	13350	830368	15950
F3	50kA	50	830349	13350	830369	15950
F3	50kA	63	830350	13350	830370	15950
F3	50kA	80	830351	13620	830371	16110
F3	50kA	100	830352	13620	830372	16110
F3	50kA	125	830353	14980	830373	19230

HSN Code: 8536



830314

Frame	Breaking Capacity	Rating	3P	MRP ₹ / Unit	4P	MRP ₹ / Unit
F3	36kA	160	830314	16560	830334	19710
F3	36kA	200	830315	18570	830335	25710
F3	36kA	250	830316	24400	830336	33670

HSN Code: 8536



830354

Frame	Breaking Capacity	Rating	3P	MRP ₹ / Unit	4P	MRP ₹ / Unit
F3	50kA	160	830354	17160	830374	21650
F3	50kA	200	830355	20020	830375	27450
F3	50kA	250	830356	28420	830376	35460

**optium™**  
ALL THAT YOU NEED  
MCCB

**Optium 2.0 (Adjustable Thermal Setting MCCB)**

HSN Code: 8536



830385



830386

Frame	Breaking Capacity	Rating	3P	MRP ₹ / Unit	4P	MRP ₹ / Unit
F4	25kA	315	830385	25940	830387	32670
F4	25kA	400	830386	26560	830388	35640
F4	36kA	315	830390	31170	830395	37970
F4	36kA	400	830391	33160	830396	40880
F4	36kA	500	830392	39030	830397	47920
F4	36kA	630	830393	41990	830398	53690
F4	50kA	315	830400	33290	830405	41110
F4	50kA	400	830401	35520	830406	43170
F4	50kA	500	830402	40690	830407	50620
F4	50kA	630	830403	43990	830408	56150

**Optium 2.0 (Adjustable Thermal Setting MCCB)**

HSN Code: 8536



830410

Frame	Breaking Capacity	Rating	3P	MRP ₹ / Unit	4P	MRP ₹ / Unit
F5	36kA	800	830410	51300	830413	62910
F5	36kA	1000	830411	73890	830414	84520
F5	36kA	1250	830412	85460	830415	101560
F5	50kA	800	830416	52820	830419	75250
F5	50kA	1000	830417	91860	830420	98500
F5	50kA	1250	830418	101310	830421	114090

**optium™**  
ALL THAT YOU NEED  
MCCB

**Accessories**

**HSN Code: 8538**



830691

Product	Frame	Cat Ref	MRP ₹ / Unit
AUXILIARY CONTACT F1 F2 F3	F1 F2 F3	830691	1400
ALARM CONTACT F1 F2 F3	F1 F2 F3	830692	1400
AUXILIARY/ALARM CONTACT F4 F5	F4-F5	830693	1780
AUX./ALARM CONTACT F1 F2 F3	F1 F2 F3	830694	2100

**HSN Code: 8538**



830602

Product	Frame	Cat Ref	MRP ₹ / Unit
SHUNT TRIP 24V AC/DC F1 F2 F3	F1 F2 F3	830602	1590
SHUNT TRIP 110V AC/DC F1 F2 F3	F1 F2 F3	830603	1590
SHUNT TRIP 230V AC/DC F1 F2 F3	F1 F2 F3	830604	1700
SHUNT TRIP 415V AC/DC F1 F2 F3	F1 F2 F3	830605	1700
SHUNT TRIP 24V AC/DC F4 F5	F4 F5	830642	3020
SHUNT TRIP 110V AC/DC F4 F5	F4 F5	830643	3020
SHUNT TRIP 230V AC/DC F4 F5	F4 F5	830644	3020
SHUNT TRIP 415V AC/DC F4 F5	F4 F5	830645	3020

**HSN Code: 8538**



830606

Product	Frame	Cat Ref	MRP ₹ / Unit
UNDERVOLTAGE 24 V DC F1 F2 F3	F1 F2 F3	830606	2610
UNDERVOLTAGE 110V AC F1 F2 F3	F1 F2 F3	830607	2610
UNDERVOLTAGE 230V AC F1 F2 F3	F1 F2 F3	830608	2610
UNDERVOLTAGE 415V AC F1 F2 F3	F1 F2 F3	830609	2610
UNDERVOLTAGE 24 V DC F4 F5	F4 F5	830646	2690
UNDERVOLTAGE 110V AC F4 F5	F4 F5	830647	2690
UNDERVOLTAGE 230V AC F4 F5	F4 F5	830648	2690
UNDERVOLTAGE 415V AC F4 F5	F4 F5	830649	2690

**optium™**  
ALL THAT YOU NEED  
MCCB

**Accessories**

**HSN Code: 8538**

	Product	Frame	Cat Ref	MRP ₹ / Unit
 <p>830611</p> <p>830626</p>	Rotary Handle Direct	F1	830611	2000
	Rotary Handle vary-Depth	F1	830612	2000
	Rotary Handle Direct	F2 F3	830626	2270
	Rotary Handle vary-Depth	F2 F3	830627	2270
	Rotary Handle Direct	F4	830651	2690
	Rotary Handle vary-Depth	F4	830652	2690
	Rotary Handle Direct	F5	830671	5260
	Rotary Handle vary-Depth	F5	830672	5260

**HSN Code: 8538**

	Product	Frame	Cat Ref	MRP ₹ / Unit
 <p>830613</p>	Ronis lock Direct RH	F1 F2 F3	830613	2190
	Ronis lock Vary-Depth RH	F1 F2 F3	830614	2190
	Ronis lock Vary-Depth RH	F4	830653	2860

**HSN Code: 8538**

	Product	Frame	Cat Ref	MRP ₹ / Unit
 <p>830615</p>	Padlock Off position	F1 F2 F3	830615	2980
	Padlock Off position	F4	830654	2880
	Padlock Off position	F5	830674	2880

**optium™**  
ALL THAT YOU NEED  
MCCB



**Accessories**

HSN Code: 8538

	Product	Frame	Cat. Nos.	MRP ₹ / Unit
 830616	PHASE INSULATOR 3P F1 F2	F1 F2	830616	470
	PHASE INSULATOR 3P F3	F3	830628	560
	PHASE INSULATOR 3P F4	F4	830655	980
	PHASE INSULATOR 3P F5	F5	830675	1330
	 830628	PHASE INSULATOR 4P F1 F2	F1 F2	830617
PHASE INSULATOR 4P F3		F3	830629	700
PHASE INSULATOR 4P F4		F4	830656	1200
PHASE INSULATOR 4P F5		F5	830676	1570

**Accessories**

**HSN Code: 8538**

	Product	Frame	Cat. Nos.	MRP ₹ / Unit
 <p>830618</p>	Spreaders 3P	F1	830618	540
	Spreaders 4P	F1	830619	790
 <p>830619</p>	Spreaders 3P	F2 F3	830632	1350
	Spreaders 4P	F2 F3	830633	2700
	Spreaders 3P	F4	830659	4280
	Spreaders 4P	F4	830660	6240
	Spreaders 3P 800/1000A	F5	830681	11050
	Spreaders 4P 800/1000A	F5	830682	16770
	Spreaders 3P 1250A	F5	830685	11500
	Spreaders 4P 1250A	F5	830686	16950

# Switch on to a reliable partner

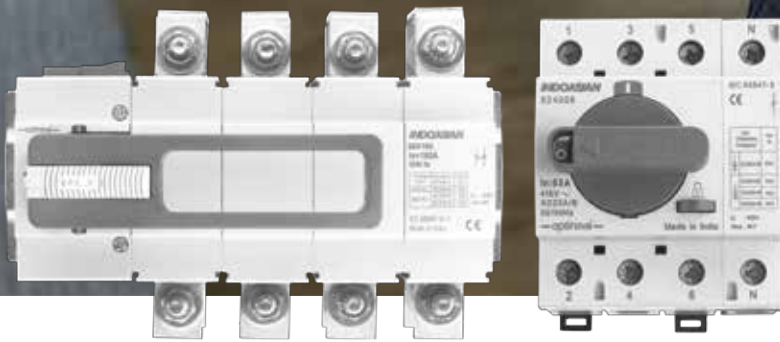

Scan to know more about the product

**Optinova** provides low-voltage switch disconnectors and transfer switching solutions for safe circuit isolation and reliable power changeover in buildings, industries, and infrastructure.

## Features

- Clear indication of mechanism with rotary handles and a padlock for safety
- IP20 protected internal mechanism with DIN-rail or plate mounting options
- High short-time withstand capacity (I<sub>cw</sub>) and ratings up to 320 A

## Benefits

- Simplifies installation & maintenance with compact form factor & snap-fit auxiliaries
- Ensures safe isolation and source changeover, reducing risk of accidents
- Delivers high reliability & uptime through robust design & high short-time withstand ratings

— optinova™ —

**4P Switch Disconnecter / Transfer Switching  
Equipment - DIN Frame**

HSN Code: 8536



824006

Rated Current	Cat Ref.	Description	MRP ₹ / Unit
32A	824006	SD DIN OPTI 63 4P 32A	2640
40A	824007	SD DIN OPTI 63 4P 40A	2790
63A	824008	SD DIN OPTI 63 4P 63A	3310

**4P Switch Disconnecter / Transfer Switching  
Equipment - Power Frame**

HSN Code: 8536



824082

Rated Current	Cat Ref.	Description	MRP ₹ / Unit
63A	824082	SD PLATE OPTI 160 4P 63A KIT	4610
100A	824083	SD PLATE OPTI 160 4P 100A KIT	6430
125A	824084	SD PLATE OPTI 160 4P 125A KIT	6950
160A	824085	SD PLATE OPTI 160 4P 160A KIT	8810
200A	824086	SD PLATE OPTI 320 4P 200A KIT	11020
250A	824087	SD PLATE OPTI 320 4P 250A KIT	13840
320A	824088	SD PLATE OPTI 320 4P 320A KIT	15370

**4P Switch Disconnecter / Transfer Switching  
Equipment - DIN Frame**

HSN Code: 8536



824106

Rated Current	Cat Ref.	Description	MRP ₹ / Unit
32A	824106	TSE DIN OPTI 63 4P 32A	4980
40A	824107	TSE DIN OPTI 63 4P 40A	5570
63A	824108	TSE DIN OPTI 63 4P 63A	6210

— optinova™ —

**4P Switch Disconnecter / Transfer Switching  
Equipment - Power Frame**

HSN Code: 8536

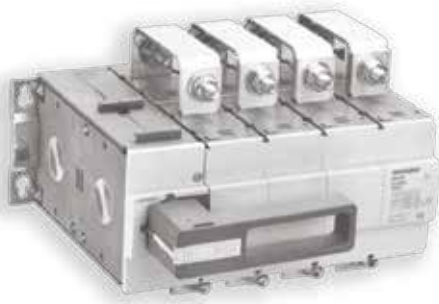

824182

Rated Current	Cat Ref.	Description	MRP ₹ / Unit
63A	824182	TSE PLATE OPTI 160 4P 63A KIT	7240
100A	824183	TSE PLATE OPTI 160 4P 100A KIT	9010
125A	824184	TSE PLATE OPTI 160 4P 125A KIT	13520
160A	824185	TSE PLATE OPTI 160 4P 160A KIT	15070
200A	824186	TSE PLATE OPTI 320 4P 200A KIT	18010
250A	824187	TSE PLATE OPTI 320 4P 250A KIT	25760
320A	824188	TSE PLATE OPTI 320 4P 320A KIT	27440

**4P Switch Disconnecter / Transfer Switching  
Equipment - Power Frame**

HSN Code: 8536

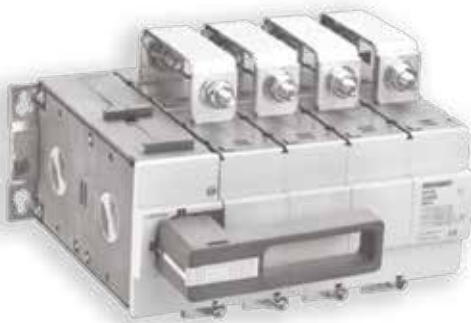

824192

Rated Current	Cat Ref.	Description	MRP ₹ / Unit
63A	824192	TSE PLATE OPTI 160 4P 63A ENC	10540
100A	824193	TSE PLATE OPTI 160 4P 100A ENC	13780
125A	824194	TSE PLATE OPTI 160 4P 125A ENC	19360
160A	824195	TSE PLATE OPTI 160 4P 160A ENC	21280
200A	824196	TSE PLATE OPTI 320 4P 200A ENC	24740
250A	824197	TSE PLATE OPTI 320 4P 250A ENC	32940
320A	824198	TSE PLATE OPTI 320 4P 320A ENC	35510

— optinova™ —

**Accessories - DIN Frame**

**HSN Code: 8538**



824201

Product	Cat Ref.	Description	MRP ₹ / Unit
Shorting links 63A for TSE	824201	OPTI Shorting links F1 4P DIN	950
Auxiliary contact Simultaneous (1 NO + 1 NC)	824208	OPTI Auxcont 1No+1NC F1&2 DIN	500
Handle Vary Depth KIT IP54	824209	OPTI Handle Depth KIT F1&2DIN	1400
SD Direct Handle	824215	OPTI Handle Direct F1&2 DIN	1120
TSE Direct Handle	824217	OPTI TSE Handle Dir F1&2DIN	1120

**Accessories - Frame 2- 320A**

**HSN Code: 8538**



824230

Product	Cat Ref.	Description	MRP ₹ / Unit
Handle Direct	824230	OPTI Handle Direct	1170
Handle Vary Depth	824231	OPTI Handle Vary Depth	1670
Spreader terminals (one side only)	824238	OPTI Sprdter termi F2 4P_1Side	2180
Inter source barrier for TSE	824239	OPTI Intersourcebar F2(3P&4P)	450
Shorting Link for TSE	824241	OPTI Linking bridge-4P	4010
Phase Barriers	824243	OPTI Phase Barriers F2 4P	280
Aux contact Simultaneous (4 NO + 4 NC)	824245	OPTI Auxcontact SimulTan F1&2	1400

**Accessories - Frame 1- 160A**

**HSN Code: 8538**



824249

Product	Cat Ref.	Description	MRP ₹ / Unit
Shorting Link for TSE	824249	OPTI Linking bridge-4P	2680
Phase Barriers	824251	OPTI Phase Barriers F1 4P	220
Inter source barrier for TSE	824252	OPTI Intersourcebar F1(3P&4P)	280
Spreader terminals (one side only)	824254	OPTI Sprdter termi F1 4P-1Side	1090

# — optinova™ —

## HRC Fuse Links & Bases

### Bolted Type (BS) Breaking Capacity $\geq 80\text{kA}$ 500 V AC 50 Hz.

HSN Code: 8536



Rating	Type	Cat Ref.	Tag Type	MRP ₹ / Unit	Unit/Carton
2, 4, 6, 8, 10, 16A	FGN	IEFGN***	Offset	110	20
2, 4, 6, 10, 16, 20, 25, 32A	FSA	IEFSA***	Offset	170	10
35, 40, 50, 63A	FSS	IEFSS***	Offset	190	10
50, 63, 80, 100, 125, 160A	FSDCP	IEDCP***	Offset	410	10
100, 125, 160, 200, 250A	FSFP	IESFP***	Offset	580	3
50, 63, 80, 100, 125A	FSDC	IESDC***	Offset	410	10
100, 125, 160, 200, 250A	FSF	IEFSF***	Central	600	3
225, 250, 300, 315, 320A	FSK	IEFSK***	Central	860	3
355, 400A	FMF	IEFMF***	Central	1660	3
355, 400, 450, 500, 560, 600, 630A	FTS	IEFTS***	Central	1920	1
355, 400, 450, 500, 560A	FTM	IEFTM***	Central	2480	1
600, 630A	FTM	IEFTM***	2 Central	3410	1

### DIN Type Breaking Capacity $\geq 80\text{kA}$ 500 V AC 50 Hz.

HSN Code: 8536



Rating	Type	Cat Ref.	Tag Type	MRP ₹ / Unit	Unit/Carton
2, 4, 6, 10, 16, 20, 25, 32, 50, 63A	Size 000	IWS00***	6	510	6
2, 4, 6, 10, 16, 20, 25, 32, 36, 40, 50, 63A	Size 00	IW000***	6	540	6
80, 100A		IW000***	6	560	6
125, 160A		IW000***	6	600	6
32, 36, 50, 63, 80, 100, 125, 160, 200A	Size 01	IW001***	3	990	3
250A		IW001250	3	1130	3
100, 125, 160, 200, 250, 315A	Size 02	IW002***	3	1450	3
400A		IW002400	3	1570	3
315, 355, 400, 425A	Size 03	IW003***	3	1990	3
500, 630A		IW003630	3	2320	3

\*HRC fuses with SC breaking capacity 120kA are available on request.

— optinova™ —

**Cylindrical Type (IFRH) Breaking Capacity > 80kA 415 V AC.**

HSN Code: 8536

	Rating Amps	Cat Ref.	MRP ₹ / Unit
	2 to 25A	IFRH0***	220
	32 to 40A	IFRH0***	220
	50A	IFRH0050	420
	63A	IFRH0063	430
	Fuse Holder Fr type (2 to 63A)	IFR00***	400

**Fuse Fittings For Bolted (BS) Type**

HSN Code: 8536

	Rating Amps	Front Connection	MRP ₹ / Unit
	20A	BFBC0020	260
	32A	BFBC0032	440
	63A	BFBC0063	650
	100A	BFBC0100	1620

**Fuse Bases for DIN Type HRC fuse links**

HSN Code: 8536

	Rating	Type	Cat Ref.	MRP ₹ / Unit	Unit/Carton
	6-160A	Size - 00	IWFB0160	690	6
	32-250A	Size - 1	IWFB1250	1320	2
	100-400A	Size - 2	IWFB2400	1980	2
	315-630A	Size - 3	IWFB3630	2510	2

# — optinova™ —

## Switch Disconnecter Fuses

HSN Code: 8536



Rated Current	Type	IN OPEN EXECUTION*		IN SHEET STEEL ENCLOSURE		Recommended HRC Fuse IndoAsian Make
		Cat Ref.	MRP ₹ / Unit	Cat Ref.	MRP ₹ / Unit	
32A BS	TPN	INO1A032	2630	INS1A032	5370	FSA
63A BS	TPN	INO1A063	3640	INS1A063	6850	FSS
100A BS	TPN	INO1A100	8010	INS1A100	11210	FSDCP
125A BS	TPN	INO1A125	8990	INS1A125	13430	FSDCP
160A BS	TPN	INO1A160	10880	INS1A160	15000	FSDCP
200A BS	TPN	INO1A200	13540	INS1A200	17440	FSF
250A BS	TPN	INO1A250	15280	INS1A250	20170	FSF
315A BS	TPN	INO1A315	19580	INS1A315	25180	FSK
400A BS	TSPN	INO1A400	24300	INS1A400	30050	FMF
32A BS	TSPN	INO1B032	3350	INS1B032	5670	FSA
63A BS	TSPN	INO1B063	4250	INS1B063	6700	FSS
100A BS	TSPN	INO1B100	9850	INS1B100	12550	FSDCP
125A BS	TSPN	INO1B125	10790	INS1B125	13430	FSDCP
160A BS	TSPN	INO1B160	13490	INS1B160	17360	FSDCP
200A BS	TSPN	INO1B200	15360	INS1B200	19210	FSF
250A BS	TSPN	INO1B250	16750	INS1B250	21560	FSF
315A BS	TSPN	INO1B315	23700	INS1B315	30120	FSK
400A BS	TSPN	INO1B400	28040	INS1B400	31330	FMF

\*Price does not include HRC Fuse

# — optinova™ —

## Switch Disconnecter Fuses

HSN Code: 8536



Rated Current	Type	IN OPEN EXECUTION*		IN SHEET STEEL ENCLOSURE		Recommended HRC Fuse IndoAsian Make
		Cat Ref.	MRP ₹ / Unit	Cat Ref.	MRP ₹ / Unit	
32A DIN	TPN	IN1OA032	2770	IN1SA032	5110	Size 000
63A DIN	TPN	IN1OA063	2770	IN1SA063	6500	Size 000
100A DIN	TPN	IN1OA100	8210	IN1SA100	11080	Size 00
125A DIN	TPN	IN1OA125	9380	IN1SA125	13390	Size 00
160A DIN	TPN	IN1OA160	11290	IN1SA160	14710	Size 00
200A DIN	TPN	IN1OA200	14100	IN1SA200	16740	Size 01
250A DIN	TPN	IN1OA250	15790	IN1SA250	20150	Size 01
315A DIN	TPN	IN1OA315	20280	IN1SA315	25090	Size 02
400A DIN	TPN	IN1OA400	25000	IN1SA400	29740	Size 02
630A DIN	TPN	IN1OA630	39380	IN1SA630	42410	Size 03
800A DIN	TPN	IN1OA800	48020	IN1SA800	60040	Size 03
32A DIN	TSPN	IN1OB032	3920	IN1SB032	5260	Size 000
63A DIN	TSPN	IN1OB063	4520	IN1SB063	5680	Size 000
100A DIN	TSPN	IN1OB100	10130	IN1SB100	11340	Size 00
125A DIN	TSPN	IN1OB125	11220	IN1SB125	12200	Size 00
160A DIN	TSPN	IN1OB160	13150	IN1SB160	16310	Size 00
200A DIN	TSPN	IN1OB200	15280	IN1SB200	17210	Size 01
250A DIN	TSPN	IN1OB250	17500	IN1SB250	19720	Size 01
315A DIN	TSPN	IN1OB315	23430	IN1SB315	26830	Size 02
400A DIN	TSPN	IN1OB400	27230	IN1SB400	33500	Size 02
630A DIN	TSPN	IN1OB630	43710	IN1SB630	45820	Size 03
800A DIN	TSPN	IN1OB800	50540	IN1SB800	66040	Size 03

\*Price does not include HRC Fuse

# Ambidex

## Switch Disconnecter Fuses

HSN Code: 8536

Rated Current	IN OPEN EXECUTION*		IN SHEET STEEL ENCLOSURE	
	Cat Ref.	MRP ₹ / Unit	Cat Ref.	MRP ₹ / Unit
400A	IN1SD400	19930	IN3ED400	31520
630A	IN1SD630	27650	IN4ED630	45980
800A	IN1SD800	32930	IN4ED800	53260

## Changeover Switches

### On-Load Changeover Switches 4 Pole

HSN Code: 8536

Rated Current	IN OPEN EXECUTION*		IN SHEET STEEL ENCLOSURE	
	Cat Ref.	MRP ₹ / Unit	Cat Ref.	MRP ₹ / Unit
400A	ICAE0400	42060	ICAS0400	66070
630A	ICAE0630	49550	ICAS0630	70800
800A	ITAE0800	69440	ITAS0800	104220
1000A	ITAE1000	125610	ITAS1000	174680
1250A	ITAE1250	168570	ITAS1250	241150
1600A	ITAE1600	193570	ITAS1600	319980
2000A	ITAE2000	283060	ITAS2000	394250
2500A	ITAE2500	389430	ITAS2500	522950
3150A	ITAE3150	400230	ITAS3150	678870



# Ambidex

## Changeover Switches

### On-Load Changeover Switches 4 Pole

HSN Code: 8536

Rating Amps	Cat Ref.	MRP ₹ / Unit
Aux.Switch 200A-630A(1NO+1NC)	ICA00AUX	290
SPREADER LINK FRAME00-4 LINKS	ICA00SPL	460

### On-Load Switch Fuse Changeover

HSN Code: 8536

Rated Current	IN OPEN EXECUTION*		IN SHEET STEEL ENCLOSURE	
	Cat Ref.	MRP ₹ / Unit	Cat Ref.	MRP ₹ / Unit
125A	ITBE0125	19610	ITBS0125	29970
200A	ITBE0200	35830	ITBS0200	53200
250A	ITBE0250	36170	ITBS0250	53700
320A	ITBE0320	37340	ITBS0320	55440
400A	ITBE0400	54090	ITBS0400	80300
630A	ITBE0630	63130	ITBS0630	93720



\*Price does not include HRC Fuse

### On-Load By-Pass Switches

HSN Code: 8536

Rated Current	IN OPEN EXECUTION*		IN SHEET STEEL ENCLOSURE	
	Cat Ref.	MRP ₹ / Unit	Cat Ref.	MRP ₹ / Unit
125A	ITCE0125	27900	ITCS0125	37670
200A	ITCE0200	35530	ITCS0200	47960
250A	ITCE0250	51610	ITCS0250	69680
320A	ITCE0320	53590	ITCS0320	72350
400A	ITCE0400	80390	ITCS0400	108530
630A	ITCE0630	91330	ITCS0630	123300

\*Price does not include HRC Fuse

# Ambidex

## Off Load Changeover Switch

HSN Code: 8536



- With enclosure
- Rated Voltage - 415V-AC 50Hz
- Type - FP

Rating	Cat Ref.	MRP ₹ / Unit
32A (DP)	OFDPO032	2530
16A	OFFPO016	4050
32A	OFFPO032	4230
63A	OFFPO063	8590
100A	OFFPO100	16780
125A	OFFPO125	23590
200A	OFFPO200	25470
250A	OFFPO250	32450
315A	OFFPO315	33500
400A	OFFPO400	39080

\*Prices for spares of Rewirable Switch Fuse Unit like Action Bar, Base Plate, End Shield, Bakelite Contact Shrouds are available on request.





## GENERAL TERMS

- This price list supersedes all previous price lists.
- All prices are in Indian Rupees only.
- All prices are Maximum Retail Prices (MRP) inclusive of GST as applicable.
- Our discount structure is exclusive of GST.
- Orders will be accepted in multiples of standard packing.
- Prices are subject to change without notice. All despatches will be as per prices prevailing on the date of despatch. Prices are ex-godown, exclusive of packing, forwarding, freight and insurance.
- Product design is subject to change without notice for continuous up-gradation.
- Despatch, if any, are subject to Delhi Jurisdiction only.
- Company reserves the right to issue amendments which may arise due to any printing errors in the price list.

## WARRANTY

IA products carry a warranty against manufacturing defects, subject to use of the product for the right application, with correct wiring/connection and normal operating conditions. Please refer to detailed Winderian warranty policy effective 1 Jan 2026.

MCBs	36 Months
RCCBs	36 Months
DBs / ACCL	12 Months
HRC Fuses	6 Months
MCCBs / BTFF Fuse Bases / Changeover Switchgears / SDF	12 Months
Time Switches	12 Months
For Wiring Devices – Switches & Socket	120 Months
Bulk Head / Ceiling Rose	12 Months
For Wiring Devices – Electronic Products (2.4 Fan Regulator, Dimmer, Buzzer, RJ45, RJ11 & TV Sockets, Bell Indicator, Motor Starter, Skirting Light)	24 Months

## CHANNEL PARTNER



CORPORATE OFFICE: V. J. Business Towers, A-6, 1st Floor, Sector-125, Noida-201301, U.P., India.

**Corporate Office:** V-1, Business Towers, A-4, 4th Floor, Sector-125, Noida-201301, U.P., India. Ph.: +91-0120-3305111 E-mail: customer.care@indoasian.com, international@indoasian.com Website: www.indoasian.com  
**Customer Care Head:** Novateur Electrical & Digital Systems Pvt. Ltd., V. J. Business Towers, A-6, 1st Floor, Sector-125, Noida-201301, U.P., India. Ph.: +91-0120-3305100 Toll Free no. 1800 103 7077 E-mail: customer.care@indoasian.com

### NORTH

#### Regional Sales Office –

**DELHI NCR**  
V. J. Business Towers  
A-6, Ground Floor,  
Sector-125, Noida-201303  
Ph.: 0120-6858900

#### Branch Office –

**CHANDIGARH**  
SCO No. 6, 2nd Floor,  
Madhya Marg, Sector 26,  
Chandigarh-160019

#### Branch Office –

**JAIPUR**  
433, 4th Floor, Ganpati Plaza,  
M. I. Road, Jaipur-302001  
Ph.: 0141-4113528

#### Branch Office –

**LUCKNOW**  
NOVATEUR ELECTRICAL & DIGITAL SYSTEMS PVT. LIMITED  
107 B & C, 1st Floor, Ratan Square  
20- A Vidhan Sabha Marg, Lucknow – 226001  
Uttar Pradesh Telephone No.: 0522 4013210

### SOUTH

#### Regional Sales Office –

**BENGALURU**  
787, 1st Floor "Skyline Vista" 15th Cross,  
100 Feet Ring Road, J P Nagar 1st Phase,  
Bangalore-560 078  
Tel: 080-46219999  
E-Mail: in-bangalore-office@indoasian.com

#### Branch Office –

**COCHIN**  
Door No.65/1317, Syda Building,  
2nd Floor, Kaloor-Kadavanthra Road,  
Kaloor, Ernakulam District,  
Kochi-682017 (Kerala)  
Ph.: 0484-4055581-88  
E-Mail: in-cochin-office@indoasian.com

#### Branch Office –

**COIMBATORE**  
Door No. 83,  
Dr. Nanjiappa Road,  
Coimbatore-641018  
Ph.: 0422-2302715  
E-Mail: in-coimbatore-office@indoasian.com

#### Branch Office –

**CHENNAI**  
No.5, 1st Floor, Mahalingapuram Main Road,  
Nungambakkam,  
Chennai-600034  
Ph.: 044-28172096, 28170527  
E-Mail: in-chennai-office@indoasian.com

#### Branch Office –

**HYDERABAD**  
312, 3rd Floor,  
Amrutha Estates,  
Himayath Nagar,  
Hyderabad-500029  
Ph.: 040-66742425  
E-Mail: in-secunderabad-office@indoasian.com

### WEST

#### Regional Sales Office –

**MUMBAI**  
401 & 408, K.P. Arrum,  
Marol Maroshi Road, Andheri East,  
Mumbai-400059  
Ph.: 022-61035800  
E-Mail: in-mumbai-office@indoasian.com

#### Branch Office –

**AHMEDABAD**  
102, 1st Floor, Shivalik High Street,  
Near Mansi Circle, Vastrapur,  
Ahmedabad-380015  
Ph.: 079-29701351-53  
E-Mail: in-ahmedabad-office@indoasian.com

#### Branch Office –

**INDORE**  
Tower B, 403 – The One  
Ravindra Nath Tagore Marg,  
Indore- 452001  
Ph.: 0731-4677510  
E-Mail: in-indore-office@indoasian.com

#### Branch Office –

**PUNE**  
311, Pride Silicon Plaza, Bhamburda,  
Shivaji Nagar, Senapati Bapat Marg,  
Pune-411016  
Ph.: 8087610722  
E-Mail: in-pune-office@indoasian.com

### EAST

#### Regional Sales Office –

**KOLKATA**  
Raikva Building" Room No. 8, 2nd Floor,  
3A Ram Mohan Garden Lane, Beliaghata E.M.Bypass,  
Kolkata-700010  
Ph.: 033-66041503  
E-Mail: in-kolkata-office@indoasian.com



**WESUPPORT**

E-mail: customer.care@indoasian.com

