

Add a touch of
shine to your life.

#AapKiShine



Designed to make you
shine with pride.

IndoAsian | Enriching quality of life since 1958

IndoAsian has always been a pioneering Indian-origin brand that has offered high-quality products. Our expertise in the power and protection product category; and wiring devices has made us a trusted name across the globe. Over the years, we have taken pride in building products that are both functional and accessible, that's why our customers feel,

"IndoAsian Makes sense."

Enhance **#AapKiShine** with Shynora

With the new Shynora range, we have taken up the challenge of introducing a wide range of switches and accessories with trendsetting designs on top of superior functionality.

So go right ahead, elevate the style quotient of your home with Shynora, and shine with pride.



Why Shynora?

They say beauty lies in the details, and with Shynora, we have taken special care to deliver a range of stunning products that not only act as the unmissable element that elevates your living space into the league of the extraordinary but also adds smart convenience to your lifestyle.



Our switches are compliant with revised BIS standard (IS 3854:2023) requirements. Also, our switches are covered additionally for use on Self-Ballasted Lamp (SBL) loads.

SBL power rating as per IS3854:2023

Switch Rating	6A, 230V~	10A, 230V~	16A, 230V~	20A, 230V~
SBL power (Watt)	100 W	100 W	200 W	250 W



Feel the sense of pride swelling within every time you bring home a Shynora product. After all, when it comes to a range of switches and accessories with style, quality and smart technology in equal measure, Shynora is in a league of its own.



5 stunning plate finishes.

Take your pick from plates in 5 dazzling finishes, designed to set your home apart from the rest.

White | Cool Grey | Chrome White | Pink | Milan Gold

2 color mechanisms

Choose from our range of mechanisms, available in 2 attractive colours.

White | Cool Grey

Cool Grey

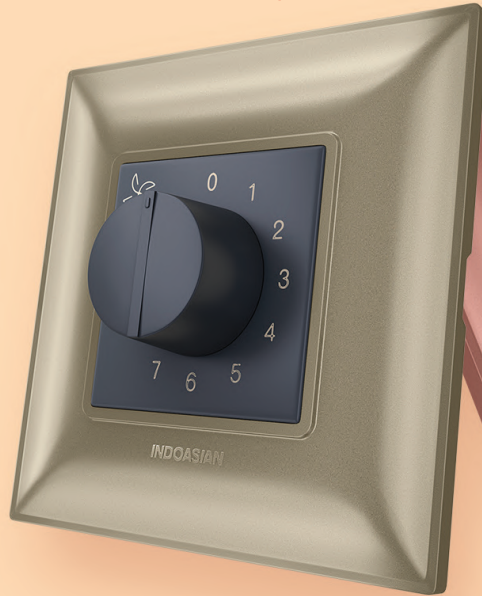

White

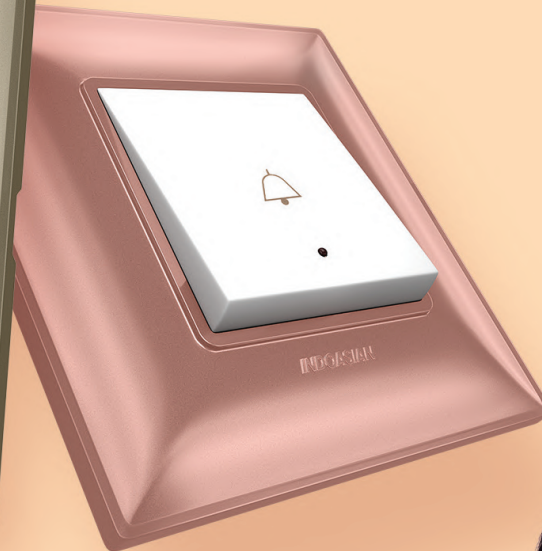

Stunning design

meets ease of use.



The Shynora range has been designed to seamlessly blend with any décor. Its switches, sockets and other mechanisms have been developed for surface as well as flush fitting with plates. And offers ease of installations to the users. With a wide range of in-built functions, our products also come with efficient LED indicators and convenient lazer markings to ensure a smooth experience.





Shynora



Quality that's built into the design.

Our products are built with high-quality raw materials, designed to be sturdy and robust. Not only do our products come with ISI* certification but also with RoHS compliance along with rigorous testing of our switches 1 lakh on/off operations, Humidity testing, Fire retardant test and others, to ensure they last over a decade.

Welcome guests **with pride.**

The Bell Push Switch guarantees a memorable initial impact on visitors. Its durable construction ensures long-lasting performance, while its timeless design maintains an everlasting brilliance.

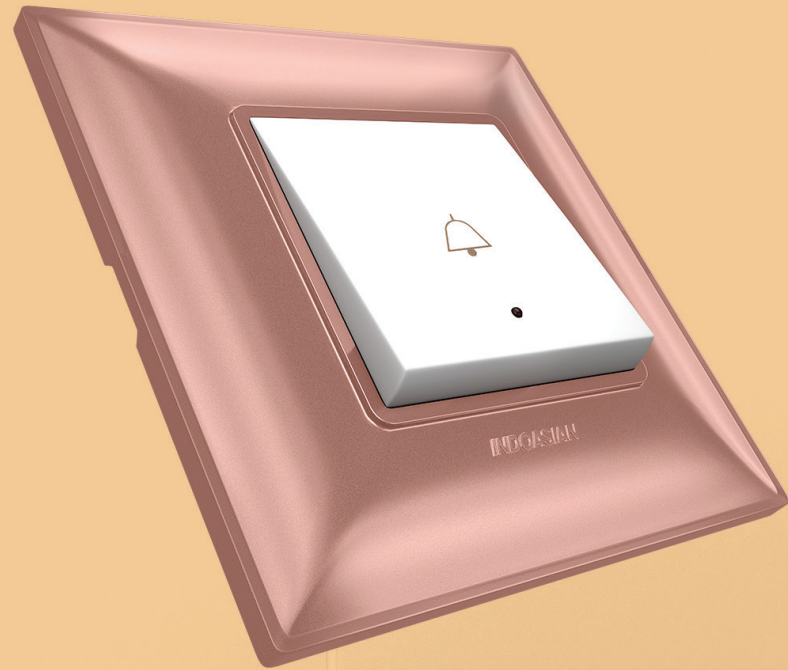

Shynora

Avoid
accidents with
**shrouded
terminals & child
safety shutters.**

Shrouded terminals help minimize exposure from accidental contact with live screws and terminals even during installation. Child safety shutters avoid the risk of small children putting their fingers inside socket thus providing safety to your loved ones.



This is the first time, IndoAsian will be launching wide range of single pole MCBs right from 6A upto 32A along with the inclusion of double pole MCBs from 16A upto 32A. They provide protection against electrical faults and equipment failure in the scenario of overload and short circuit.



Shynora

Future-ready



**Add speed and
convenience**
at every step

Experience high-speed network connectivity with Shynora 8-pin ethernet sockets, ideal for computers, printers, network storage devices and cables for DSL modems.

USB Charger

Meet your daily charging requirements in style without having to carry multiple accessories. Shynora charging solution comes with Type A & Type C port with a rating 3.0A to charge multiple devices at a single point of time. Also available in Type A & Type C single port models.



Shynora



The very best in Hospitality Solutions

Shynora adds shine to not just homes but to hospitality industry as well. The range comes with all the requirements that one can expect to have in a commercial establishment.

Shynora offers wide range of hospitality solutions that includes DND & MMR internal and external units, door entry switches with both mechanical and electronic operations, shaver sockets, skirting lights, USB charging solutions etc to make your guest feel comfortable during their stay.

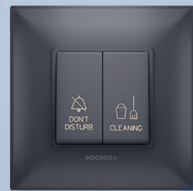

Nothing less than
the highest
in safety.



When it comes to ensuring the safety of our products, we have left no stone unturned.

Shynora products undergo stringent tests at multiple levels and come with the ISI mark that testifies to their safety. Our switches can withstand high temperatures so that your home always stays protected. What's more, all our sockets have an integrated safety shutter to prevent from shocks.





The assurance of a 10-year warranty.

Shynora products ensure a warranty against manufacturing defects, subject to use of the product for the right application, with correct wiring/connection and normal operation conditions. Please refer to the detailed IndoAsian warranty policy.

**For All Switches (Without Neon Lamp)
& Socket: 10 Years**

For all Other Products: 2 Years

Our Range



Switch 6A with indicator



Switch 6A with light marking



Switch 6A with fan marking



Switch 10A with indicator



Switch 20A DP with indicator



Switch 6A 2 way



Switch with indicator - 2M



Switch 32A DP with indicator



Bell Push (with bell symbol)



Bell Push (with bell symbol) with indicator



Bell Push (with bell symbol) with indicator - 2M



Socket 6A 3 Pin (Round) with shutter ISI mark



Socket 6/16A socket ISI with shutter

The Shynora wiring system device consists of switches, sockets and indicators that are packed with style, functions and features.

This high-quality range extends from residential to offices to hospitality that are ISI certified. The range includes defined dimmers and fan regulators, USBs, Hospitality products (Key card, DND & MMR), call bells, skirting lights, Modular MCBs, 16A socket and motor starters and many more...



**USB Charger
(Type C)- 1.5A- 1 Port**



**USB Charger
(Type A+C)- 3.0A- 2 Port**



**USB Charger
(Type A 3A) - 2 Ports**



**USB Charger
(Type A 1.5A) 1-port**



**Tel socket
(with shutter)**



**RJ45 (Cat 6)
with shutter**



TV Socket



Buzzer 230V



**Fan regulator 100
Watt ISI mark**



**Fan regulator 100 Watt
360 degree - 2M ISI mark**



**Fan Regulator 8-Step
100 Watt**



Dimmer 400W



Dimmer 500W - 2M



Electronic Bell



Bell call indicator



Flat Indicator Red



Skirting Light



**MCB
DP 16/20/25/32A**



**Power unit with
20A/25A MCB and Plug**



**MCB
6/10/16/20/25/32A**



Motor Starter 16/25A



**Key tag switch 32A DP
(Mechanical)**



**Key card switch
16A and Key FOB**



DND Internal unit



DND External unit



Shaver Socket



Blank



Cable outlet

...and
**many
more...**





WHITE MECHANISMS

SWITCHES 6A 230 V AC



Cat. Nos.	Description	Module	Pack
810600	6A 1 Way Switch	1	1/20/400
810610	6A 2 Way Switch	1	1/20/200
810602	6A 1 Way Switch with Indicator	1	1/20/200
810604	6A 1 Way Switch with "Light" Marking	1	1/20/200
810605	6A 1Way Switch with "Fan" Marking	1	1/20/200

SWITCHES 10A 230 V AC



Cat. Nos.	Description	Module	Pack
810673	10A 1 Way Switch	1	1/20/200
810674	10A 2 Way Switch	1	1/20/200
810675	10A 1 Way Switch with Indicator	1	1/20/200

SWITCHES 16A 230 V AC



Cat. Nos.	Description	Module	Pack
810601	16A 1 Way Switch	1	1/20/200
810611	16A 2 Way Switch	1	1/10/100
810603	16A 1 Way Switch with Indicator	1	1/20/200

SWITCHES 20A 230 V AC

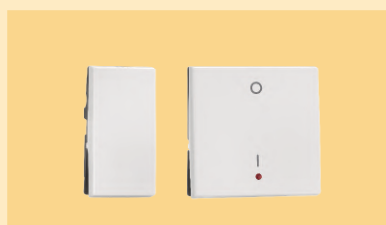

Cat. Nos.	Description	Module	Pack
810606	20A 1 Way Switch	1	1/20/200
810607	20A 1 Way Switch with Indicator	1	1/20/200
810609	20A SP 1 Way Switch	2	1/10/100
810612	20A DP Switch with Indicator	2	1/10/100

SWITCHES 25A 230 V AC



Cat. Nos.	Description	Module	Pack
810608	25A 1 Way Switch with Indicator	1	1/20/200

WHITE MECHANISMS

SWITCHES 32A 230 V AC



Cat. Nos.	Description	Module	Pack
810613	32A DP Switch with Indicator	2	1/10/100

BELL PUSH BUTTON 6A 230 V AC



Cat. Nos.	Description	Module	Pack
810615	6A Bell Push Switch	1	1/20/200
810616	6A Bell Push Switch with Indicator	1	1/20/200
810617	6A Bell Push Switch with Indicator	2	1/10/100

ACCESSORIES FOR SWITCHES



Cat. Nos.	Description	Module	Pack
810650	LED Indicator for Switches (Red)	-	1/5/25

SOCKET 240 V AC

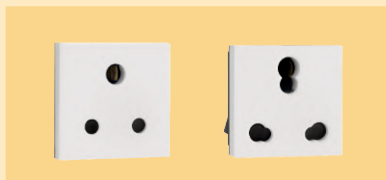

Cat. Nos.	Description	Module	Pack
810620	6A 3 Pin Round Socket with Shutter (ISI mark)	2	1/20/200
810621	6A/16A 3 Pin Socket with Shutter (ISI Mark)	2	1/10/100

DIMMERS AND FAN REGULATORS



Cat. Nos.	Description	Module	Pack
810641	Light Dimmer -400W	1	1/10/100
810642	Light Dimmer -500W	2	1/10/100
810638	Fan 4 Step Regulator 100W (ISI mark)	1	1/10/100
810639	Fan Step Regulator 360 deg 100W (ISI mark)	2	1/10/100
810640	Fan 8 step Regulator 100W	2	1/10/100

WHITE MECHANISMS

SKIRTING LIGHT



Cat. Nos.	Description	Module	Pack
810649	Skirting Light	2	1/5/50

INDICATOR



Cat. Nos.	Description	Module	Pack
810645	Flat Indicator Red	1	1/20/200

BELL CALL INDICATOR



Cat. Nos.	Description	Module	Pack
810644	Bell Call Indicator	1	1/20/100

BUZZER



Cat. Nos.	Description	Module	Pack
810637	Buzzer -230V	1	1/20/100

HOSPITALITY FUNCTION

HOTEL KEYCARD SWITCH



Cat. Nos.	Description	Module	Pack
810614	32A DP Keytag Switch (Mechanical)	2	1/10
810646	Key Card SW 16A + Key Fob	2	1/1/10

HOSPITALITY FUNCTION

HOTEL "DND AND MMR"



Cat. Nos.	Description	Module	Pack
810647	DND Internal Unit	2	1/10/100
810648	DND External Unit	2	1/10/100

SHAVER SOCKET



Cat. Nos.	Description	Module	Pack
810666	Shaver Socket	4	1/5/20

SOCKETS AND CONNECTORS

TV SOCKETS



Cat. Nos.	Description	Module	Pack
810633	TV Socket	1	1/20/200

DATA & VOICE



Cat. Nos.	Description	Module	Pack
810631	Telephone Socket - RJ11 with Shutter	1	1/20/200
810632	Computer Socket- RJ45 Cat 6 with Shutter	1	1/20/200

SOUND - ELECTRONIC BELL



Cat. Nos.	Description	Module	Pack
810643	Electronic Bell	2	1/10/100

PROTECTORS AND ACCESSORIES

MOTOR STARTER



Cat. Nos.	Description	Module	Pack
810664	16A Motor Starter	2	10/50
810665	25A Motor Starter	2	10/50

MODULAR MCB (IS : 608981:2002)



Cat. Nos.	Description	Module	Pack
810654	6A Mini MCB SP C Curve	1	1/1/100
810655	10A Mini MCB SP C Curve	1	1/1/100
810656	16A Mini MCB SP C Curve	1	1/1/100
810657	20A Mini MCB SP C Curve	1	1/1/100
810658	25A Mini MCB SP C Curve	1	1/1/100
810659	32A Mini MCB SP C Curve	1	1/1/100
810660	16A Mini MCB DP C Curve	2	1/1/100
810661	20A Mini MCB DP C Curve	2	1/1/100
810662	25A Mini MCB DP C Curve	2	1/1/100
810663	32A Mini MCB DP C Curve	2	1/1/100

POWER UNIT



Cat. Nos.	Description	Module	Pack
810625	Power Unit with 20A MCB & 16A Plug	3	1/10
810626	Power Unit with 25A MCB & 16A Plug	3	1/10

ELECTRONIC FUNCTION

USB CHARGERS (IS13252 (PART 1) / IEC 60950-1)



Cat. Nos.	Description	Module	Pack
810652	USB Charger 1500mA Type A	1	1/10/100
810651	Double USB Charger 3000mA Type A	2	1/10/100

ELECTRONIC FUNCTION

USB CHARGERS (IS13252 (PART 1) / IEC 60950-1)



Cat. Nos.	Description	Module	Pack
810670	USB Charger 1500mA Type C	1	1/10/100
810669	Double USB Charger 3000mA Type A + C	2	1/10/100

ACCESSORIES



Cat. Nos.	Description	Module	Pack
810667	1 Module Blank Plate	1	1/40/400
810668	Cable Outlet	1	1/20/100

COOL GREY MECHANISMS

SWITCHES 6A 230 V AC



Cat. Nos.	Description	Module	Pack
810700	6A 1 Way Switch	1	1/20/400
810710	6A 2 Way Switch	1	1/20/200
810702	6A 1 Way Switch with Indicator	1	1/20/200
810704	6A 1 Way Switch with "Light" Marking	1	1/20/200
810705	6A 1 Way Switch with "Fan" Marking	1	1/20/200

SWITCHES 16A 230 V AC



Cat. Nos.	Description	Module	Pack
810701	16A 1 Way Switch	1	1/20/200
810711	16A 2 Way Switch NEW	1	1/10/100
810703	16A 1 Way Switch with Indicator	1	1/20/200

COOL GREY MECHANISMS

SWITCHES 20A 230 V AC



Cat. Nos.	Description	Module	Pack
810706	20A 1 Way Switch	1	1/20/200
810707	20A 1 Way Switch with Indicator	1	1/20/200
810709	20A SP 1 Way Switch	2	1/10/100
810712	20A DP Switch with Indicator	2	1/10/100

SWITCHES 25A 230 V AC



Cat. Nos.	Description	Module	Pack
810708	25A 1 Way Switch with Indicator	1	1/20/200

SWITCHES 32A 230 V AC



Cat. Nos.	Description	Module	Pack
810713	32A DP Switch with Indicator	2	1/10/100

BELL PUSH BUTTON 6A 230 V AC



Cat. Nos.	Description	Module	Pack
810715	6A Bell Push Switch	1	1/20/200
810716	6A Bell Push Switch with Indicator	1	1/20/200
810717	6A Bell Push Switch with Indicator	2	1/10/100

SOCKET 240 V AC

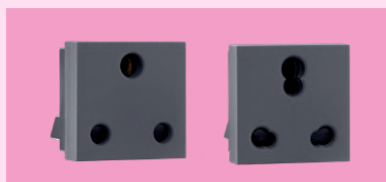

Cat. Nos.	Description	Module	Pack
810720	6A 3 Pin Round Socket with Shutter (ISI mark)	2	1/20/200
810721	6A/16A 3 Pin Socket with Shutter (ISI Mark)	2	1/10/100

COOL GREY MECHANISMS

DIMMERS AND FAN REGULATORS



Cat. Nos.	Description	Module	Pack
810741	Light Dimmer -400W	1	1/10/100
810742	Light Dimmer -500W	2	1/10/100
810738	Fan 4 Step Regulator 100W (ISI mark)	1	1/10/100
810739	Fan Step Regulator 360 deg 100W (ISI mark)	2	1/10/100
810740	Fan 8 step Regulator 100W	2	1/10/100

SKIRTING LIGHT



Cat. Nos.	Description	Module	Pack
810749	Skirting Light	2	1/5/50

INDICATOR



Cat. Nos.	Description	Module	Pack
810745	Flat Indicator Red	1	1/20/200

BUZZER



Cat. Nos.	Description	Module	Pack
810737	Buzzer -230V	1	1/20/100

HOSPITALITY FUNCTION

HOTEL KEYCARD SWITCH



Cat. Nos.	Description	Module	Pack
810714	32A DP Keytag Switch (Mechanical)	2	1/10
810746	Key Card SW 16A + Key Fob	2	1/1/10

HOSPITALITY FUNCTION

HOTEL "DND AND MMR"



Cat. Nos.	Description	Module	Pack
810747	DND Internal Unit	2	1/10/100
810748	DND External Unit	2	1/10/100

SHAVER SOCKET



Cat. Nos.	Description	Module	Pack
810766	Shaver Socket	4	1/5/20

SOCKETS AND CONNECTORS

TV SOCKETS

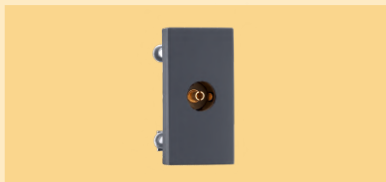

Cat. Nos.	Description	Module	Pack
810733	TV Socket	1	1/20/200

DATA & VOICE



Cat. Nos.	Description	Module	Pack
810731	Telephone Socket - RJ11 with Shutter	1	1/20/200
810732	Computer Socket- RJ45 Cat 6 with Shutter	1	1/20/200

PROTECTORS AND ACCESSORIES

MOTOR STARTER



Cat. Nos.	Description	Module	Pack
810764	16A Motor Starter	2	10/50
810765	25A Motor Starter	2	10/50

PROTECTORS AND ACCESSORIES

MODULAR MCB (IS : 608981:2002)



Cat. Nos.	Description	Module	Pack
810754	6A Mini MCB SP C Curve	1	1/1/100
810755	10A Mini MCB SP C Curve	1	1/1/100
810756	16A Mini MCB SP C Curve	1	1/1/100
810757	20A Mini MCB SP C Curve	1	1/1/100
810758	25A Mini MCB SP C Curve	1	1/1/100
810759	32A Mini MCB SP C Curve	1	1/1/100

POWER UNIT



Cat. Nos.	Description	Module	Pack
810725	Power Unit with 20A MCB & 16A Plug	3	1/10
810726	Power Unit with 25A MCB & 16A Plug	3	1/10

ELECTRONIC FUNCTION

USB CHARGERS (IS13252 (PART 1) / IEC 60950-1)



Cat. Nos.	Description	Module	Pack
810752	USB Charger 1500mA Type A	1	1/10/100
810751	Double USB Charger 3000mA Type A	2	1/10/100

USB CHARGERS (IS13252 (PART 1) / IEC 60950-1)



Cat. Nos.	Description	Module	Pack
810770	USB Charger 1500mA Type C	1	1/10/100
810769	Double USB Charger 3000mA Type A + C	2	1/10/100

ACCESSORIES

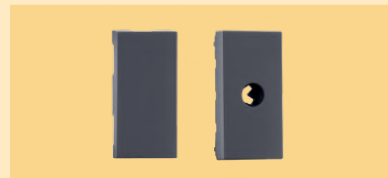

Cat. Nos.	Description	Module	Pack
810767	1 Module Blank Plate	1	1/40/400
810768	Cable Outlet	1	1/20/100

PLATE & FRAME

WHITE MODULAR PLATE WITH SUPPORT FRAME

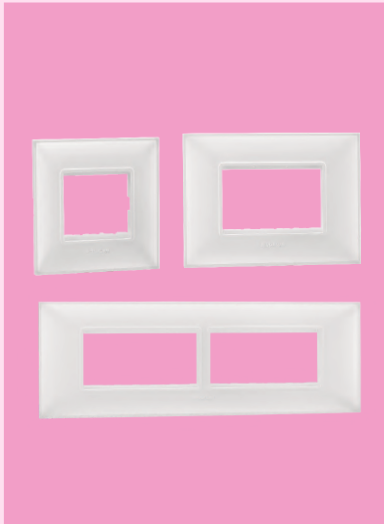

Cat. Nos.	Description	Module	Pack
810800	White Plate + Frame, 1 module	1	1/10/100
810801	White Plate + Frame, 2 module	2	1/10/100
810802	White Plate + Frame, 3 module	3	1/10/100
810803	White Plate + Frame, 4 module	4	1/10/100
810804	White Plate + Frame, 6 module	6	1/10/100
810805	White Plate + Frame, 8 module	8	1/10/100
810806	White Plate + Frame, 2X4 module	8	1/5/25
810807	White Plate + Frame, 9 module	9	1/5/50
810808	White Plate + Frame, 12 module	12	1/5/25
810809	White Plate + Frame, 16 module	16	1/5/25
810810	White Plate + Frame, 18 module	18	1/5/25

COOL GREY MODULAR PLATE WITH SUPPORT FRAME

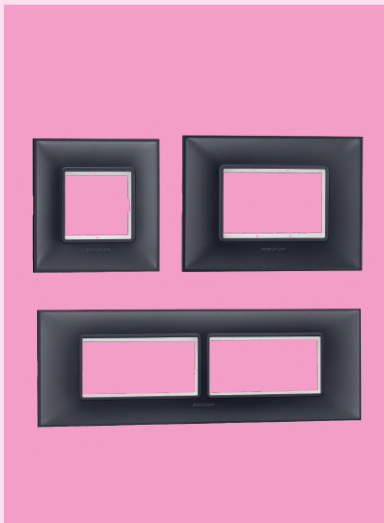

Cat. Nos.	Description	Module	Pack
810811	Cool Grey Plate + Frame, 1 module	1	1/10/100
810812	Cool Grey Plate + Frame, 2 module	2	1/10/100
810813	Cool Grey Plate + Frame, 3 module	3	1/10/100
810814	Cool Grey Plate + Frame, 4 module	4	1/10/100
810815	Cool Grey Plate + Frame, 6 module	6	1/10/100
810816	Cool Grey Plate + Frame, 8 module	8	1/10/100
810817	Cool Grey Plate + Frame, 2X4 module	8	1/5/25
810818	Cool Grey Plate + Frame, 9 module	9	1/5/50
810819	Cool Grey Plate + Frame, 12 module	12	1/5/25
810820	Cool Grey Plate + Frame, 16 module	16	1/5/25
810821	Cool Grey Plate + Frame, 18 module	18	1/5/25

PLATE & FRAME

CHROME MODULAR PLATE WITH SUPPORT FRAME

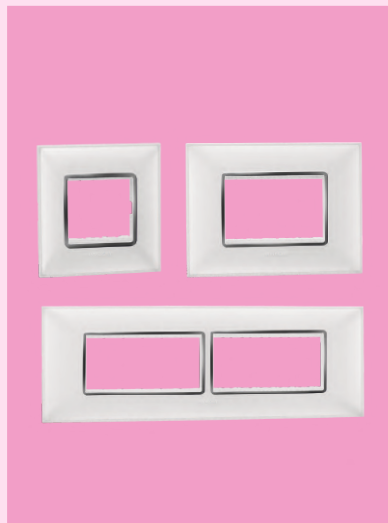

Cat. Nos.	Description	Module	Pack
810833	Chrome Plate + Frame, 1 module	1	1/10/100
810834	Chrome Plate + Frame, 2 module	2	1/10/100
810835	Chrome Plate + Frame, 3 module	3	1/10/100
810836	Chrome Plate + Frame, 4 module	4	1/10/100
810837	Chrome Plate + Frame, 6 module	6	1/10/100
810838	Chrome Plate + Frame, 8 module	8	1/10/100
810839	Chrome Plate + Frame, 2X4 module	8	1/5/25
810840	Chrome Plate + Frame, 9 module	9	1/5/50
810841	Chrome Plate + Frame, 12 module	12	1/5/25
810842	Chrome Plate + Frame, 16 module	16	1/5/25
810843	Chrome Plate + Frame, 18 module	18	1/5/25

PINK MODULAR PLATE WITH SUPPORT FRAME

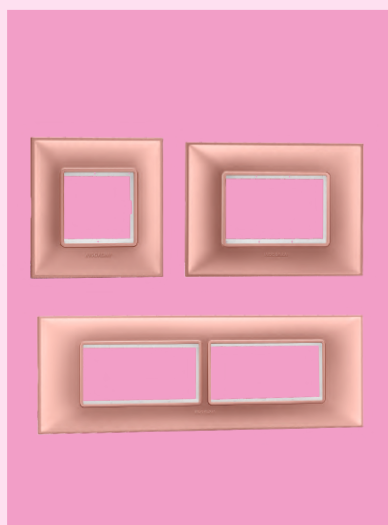

Cat. Nos.	Description	Module	Pack
810844	Pink Plate + Frame, 1 module	1	1/10/100
810845	Pink Plate + Frame, 2 module	2	1/10/100
810846	Pink Plate + Frame, 3 module	3	1/10/100
810847	Pink Plate + Frame, 4 module	4	1/10/100
810848	Pink Plate + Frame, 6 module	6	1/10/100
810849	Pink Plate + Frame, 8 module	8	1/10/100
810850	Pink Plate + Frame, 2X4 module	8	1/5/25
810851	Pink Plate + Frame, 9 module	9	1/5/50
810852	Pink Plate + Frame, 12 module	12	1/5/25
810853	Pink Plate + Frame, 16 module	16	1/5/25
810854	Pink Plate + Frame, 18 module	18	1/5/25

PLATE & FRAME

MILAN GOLD MODULAR PLATE WITH SUPPORT FRAME

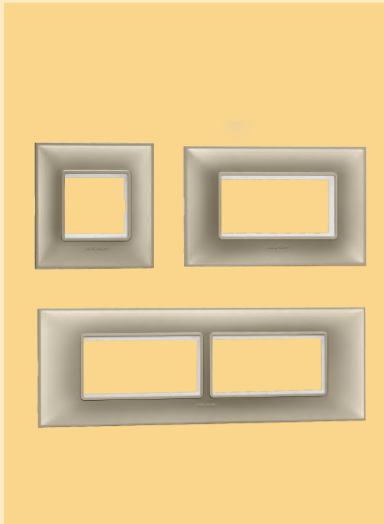

Cat. Nos.	Description	Module	Pack
810855	Milan Gold Plate + Frame, 1 module	1	1/10/100
810856	Milan Gold Plate + Frame, 2 module	2	1/10/100
810857	Milan Gold Plate + Frame, 3 module	3	1/10/100
810858	Milan Gold Plate + Frame, 4 module	4	1/10/100
810859	Milan Gold Plate + Frame, 6 module	6	1/10/100
810860	Milan Gold Plate + Frame, 8 module	8	1/10/100
810861	Milan Gold Plate + Frame, 2X4 module	8	1/5/25
810862	Milan Gold Plate + Frame, 9 module	9	1/5/50
810863	Milan Gold Plate + Frame, 12 module	12	1/5/25
810864	Milan Gold Plate + Frame, 16 module	16	1/5/25
810865	Milan Gold Plate + Frame, 18 module	18	1/5/25

METAL FLUSH BOX



Cat. Nos.	Description	Module	Pack
800172	Metal Flush Box, 1/2 Module	1/2	40
800173	Metal Flush Box, 3 Module	3	40
800174	Metal Flush Box, 4 Module	4	40
800176	Metal Flush Box, 6 Module	6	20
800177	Metal Flush Box, 8 Module (vertical)	8	20
800178	Metal Flush Box, 8 Module	8	20
810867	Metal Flush Box, 9 Module	9	20
800175	Metal Flush Box, 12 Module	12	10
800179	Metal Flush Box, 16 Module	16	10
800180	Metal Flush Box, 18 Module	18	10

WHITE SURFACE BOX



Cat. Nos.	Description	Module	Pack
800182	Plastic Surface Box, 1/2 Module	1/2	50
800183	Plastic Surface Box, 3 Module	3	35
800184	Plastic Surface Box, 4 Module	4	25
800186	Plastic Surface Box, 6 Module	6	10
800187	Plastic Surface Box, 8 Module (vertical)	8	15
810866	Plastic Surface Box, 8 Module	8	10
800185	Plastic Surface Box, 12 Module	12	10
800189	Plastic Surface Box, 16 Module	16	10
800190	Metal Surface Box, 18 Module	18	10

COVER PLATES

1 module
810800 810811
810833 810844
810855

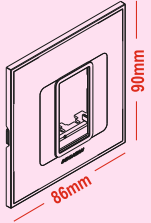

2 module
810801 810812
810834 810845
810856

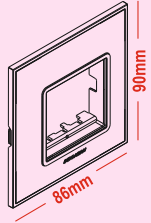

3 module
810802 810813
810835 810846
810857

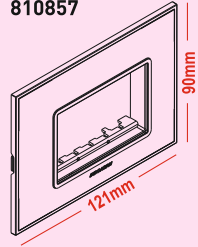

4 module
810803 810814
810836 810847
810858

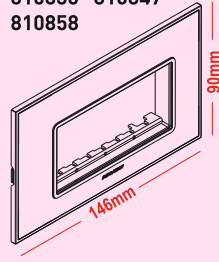

6 module
810804 810815
810837 810848
810859

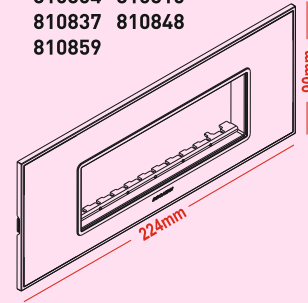

8 module (Horizontal)
810805 810816
810838 810849
810860

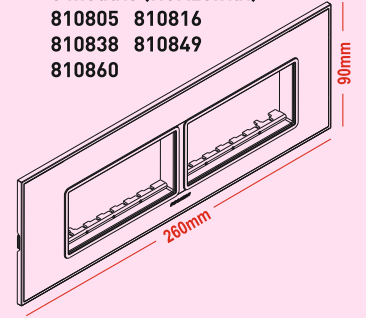

FLUSH BOXES-METAL

1 & 2 module
800172

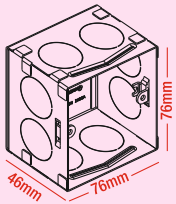

3 module
800173

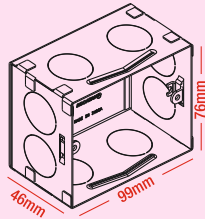

4 module
800174

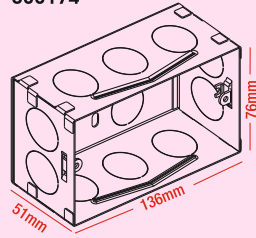

6 module
800176

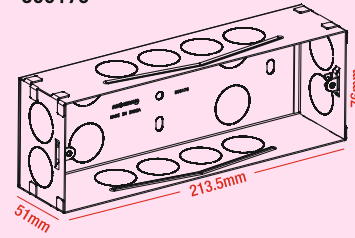

8 module (Horizontal)
800178

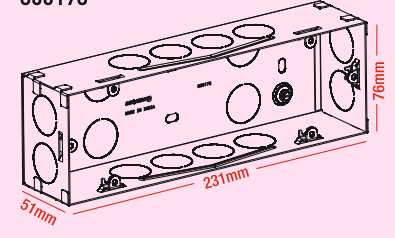

SURFACE BOXES

1 & 2 module
800182

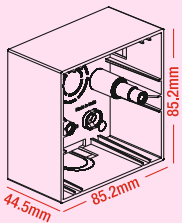

3 module
800183

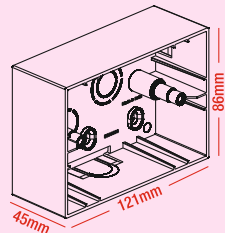

4 module
800184

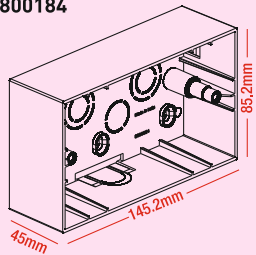

6 module
800186

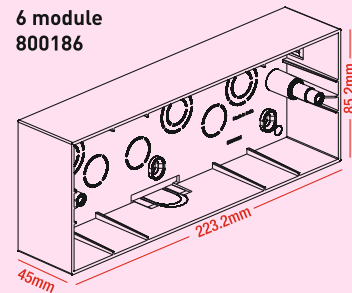

8 module (Horizontal)
810866

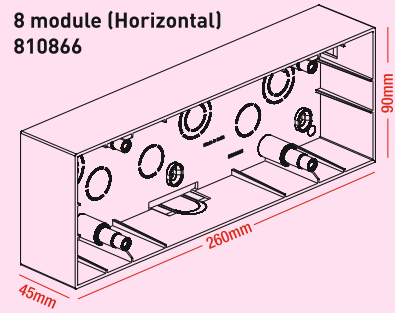

8 module (Vertical)
810806 810817
810839 810850
810861

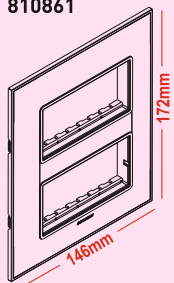

9 module
810807 810818
810840 810851
810862

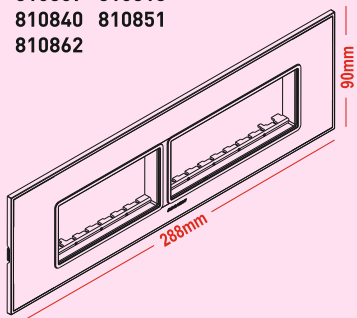

12 module
810808 810819
810841 810852
810863

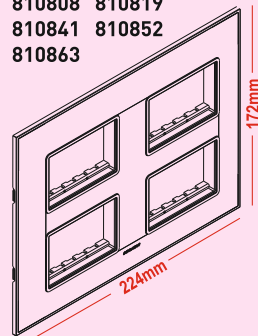

16 module
810809 810820
810842 810853
810864

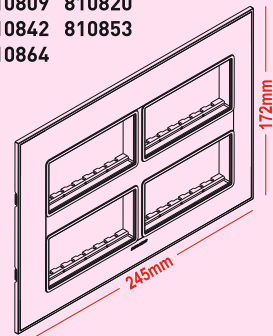

18 module
810810 810821
810843 810854
810865

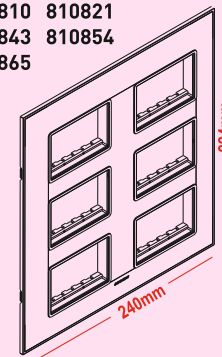

8 module (Vertical)
800177

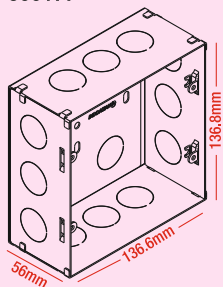

9 module
810867

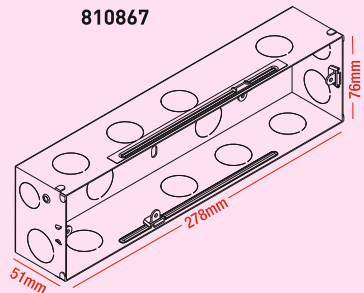

12 module
800175

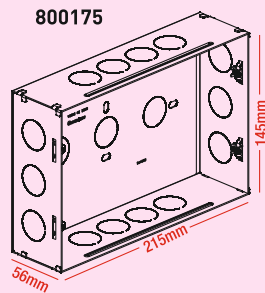

16 module
800179

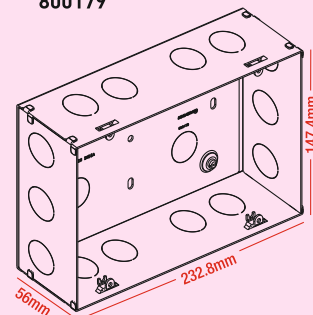

18 module
800180

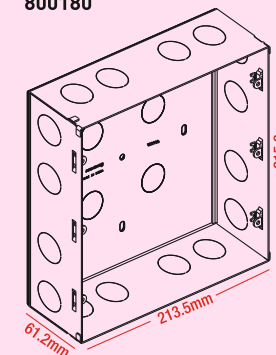

8 module (Vertical)
800187

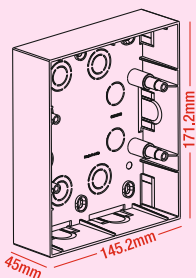

12 module
800185

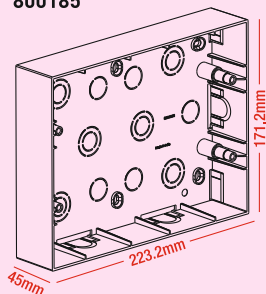

16 module
800189

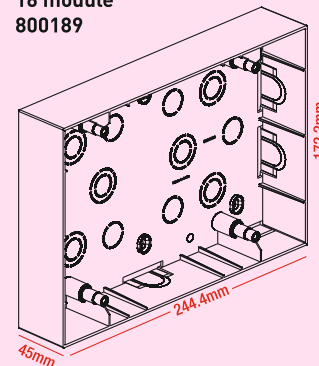

18 module
800190

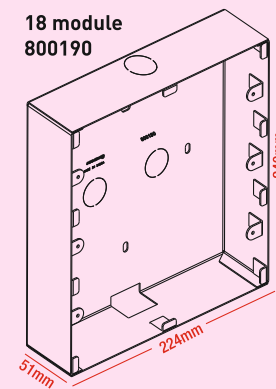

CORPORATE OFFICE:

V. J. Business Tower, A-6, First Floor, Sector - 125, Noida - 201301, UP, India. Ph.: +91-120-3305100 E-mail: Customer.care@indoasian.com Website : www.indoasian.com

NORTH

Regional Sales office

DELHI NCR

V. J. Business Towers
A-6, Ground Floor, Sector-125,
Noida-201301
Ph.: 0120-6858900
E-Mail: in-delhi-office@indoasian.com

Branch office

CHANDIGARH

SCO No. 6, 2nd Floor,
Madhya Marg, Sector 26,
Chandigarh-160019
E-Mail: in-chandigarh-office@indoasian.com

Branch office

JAIPUR

433, 4th Floor, Ganpati Plaza,
M. I. Road, Jaipur-302001
Ph.: 0141-4113528
E-Mail: in-jaipur-office@indoasian.com

Branch office

LUCKNOW

301, 3rd Floor, Chintel House,
Station Road, Lucknow-226001
Ph.: 0522-4013210
E-Mail: in-lucknow-office@indoasian.com

SOUTH

Regional Sales office

BANGALORE

787, 1st Floor "Skyline Vista"
15th Cross, 100 Feet Ring Road
J P Nagar 1st Phase, Bangalore-560 078
Tel: 080-46219999
E-Mail: in-bangalore-office@indoasian.com

Branch office

KERALA

Door No.65/1317, Syda Building,
2nd Floor, Kaloor-Kadavanthra Road,
Kaloor, Ernakulam District,
Kochi-682017 (Kerala)
Ph.: 0484-4055581-88
E-Mail: in-cochin-office@indoasian.com

Branch office

COIMBATORE

Door No. 83,
Dr. Nanjappa Road,
Coimbatore-641018
Ph.: 0422-2302715
E-Mail: in-coimbatore-office@indoasian.com

Branch office

CHENNAI

No.5, 1st Floor, Mahalingapuram Main Road,
Nungambakkam, Chennai-600034
Ph.: 044-28172096, 28170527
E-Mail: in-chennai-office@indoasian.com

Branch office

HYDERABAD

312, 3rd Floor,
Amrutha Estates, Himayath Nagar,
Hyderabad-500029
Ph.: 040-66742425
E-Mail: in-secunderabad-office@indoasian.com

WEST

Regional Sales office

MUMBAI

401 & 408, K.P. Arrum,
Marol Morshi Road, Andheri East,
Mumbai-400059
Ph.: 022-61035800
E-Mail: in-mumbai-office@indoasian.com

Branch office

AHMEDABAD

102, 1st Floor, Shivalik High Street,
Near Mansi Circle, Vastrapur,
Ahmedabad-380015
Ph.: 079-29701351-53
E-Mail: in-ahmedabad-office@indoasian.com

Branch office

INDORE

Tower B, 403 - The One
Ravindra Nath Tagore Marg,
Indore- 452001
Ph.: 0731-4677510
E-Mail: in-indore-office@indoasian.com

Branch office

PUNE

311, Pride Silicon Plaza,
Bhamburda, Shivaji Nagar,
Senapati Bapat Marg,
Pune-411016
Ph.: 8087610722
E-Mail: in-pune-office@indoasian.com

EAST

Regional Sales office

KOLKATA

"Raikva Building" Room No. 8, 2nd Floor,
3A Ram Mohan Garden Lane,
Beliaghata E.M.Bypass, Kolkata-700010
Ph.: 033-66041503
E-Mail: in-kolkata-office@indoasian.com

CUSTOMER CARE:

V. J. Business Tower, A-6, First Floor, Sector - 125, Noida - 201301, UP, India. Ph.: +91-120-3305100 E-mail: Customer.care@indoasian.com